

# TOP DEAL

**KS TOOLS**

WWW.KSTOOLS.COM

*No Limits!*

ONZE KERNCOMPETENTIE:

**KWALITEIT VOOR EEN SCHERPE PRIJS!**

EVOLUTION  
SERIES

**NIEUW**



Complete  
stuklijst

917.0255

1/4" + 3/8" + 1/2" + 5/16"

255 ONDERDELEN,  
VOOR SLECHTS

**119,90**

**EDELSTAHL**  
ROSTFREI

**i** **397**  
Meer informatie

**P<sub>10</sub>**

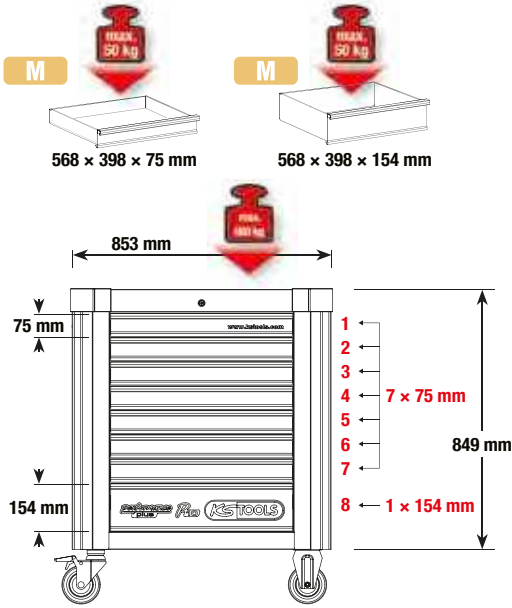

**KIES UW POWER-PAKKET**

810.7397

- met papierrolhouder
- met spuitbus houder
- Stabiele kogellagers
- Antistatische wielen met rem
- 1 0** OPTION

**i** **397**  
Meer informatie

**P<sub>15</sub>**

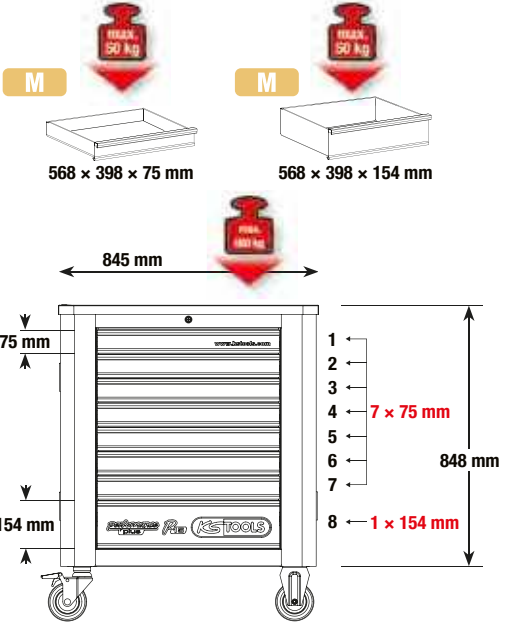

815.7397

**HET PERFECTE PAKKET MET 397 ONDERDELEN**

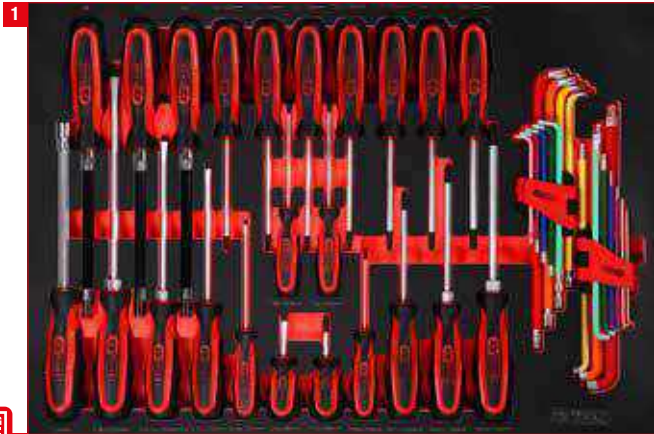

41 Schroevendraaierset



41 Sleutelset

**2699,00**

810.7397 P10 gereedschapwagenset met 397 gereedschappen



111 1/4" + 3/8" + 1/2" Dopsleutelset

**2799,00**

815.7397 P15 gereedschapwagenset met 397 gereedschappen



111 1/2" bit-doppenset



28 Tangen- en vijlenset



43 Olie- en bandenserviceset



22 Hamer- en beitset

# HARTELIJK WELKOM IN



Meer informatie



**3799,00**



Geïntegreerde Randbescher-  
ming



met spuitbus houder



Stabiele kogellagers



Antistatische wielen met rem



Slot afsluitbaar

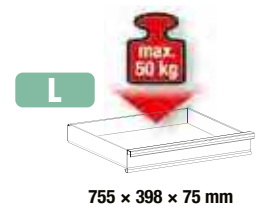
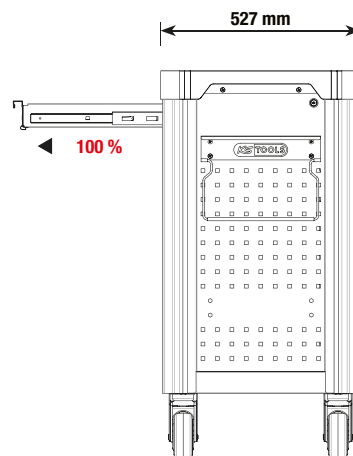
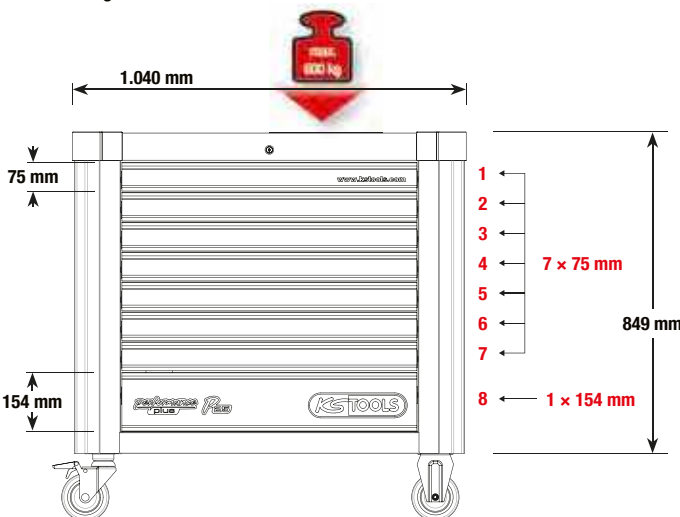

825.8564

# DE KONINGSKLASSE!

Performance  
plus

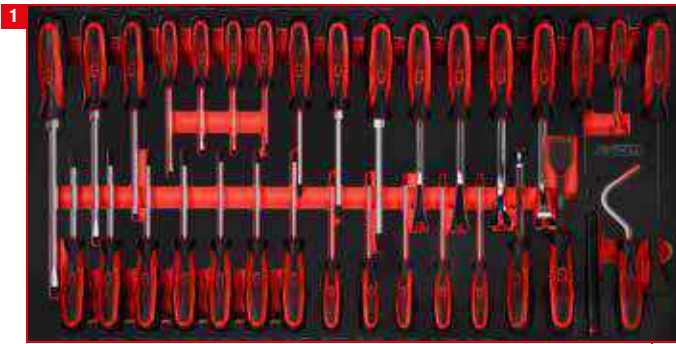

Schroevendraaierset

33



1/4" + 3/8" Dopsleutelset

213



1/2" Dopsleutelset

86



Sleutelset

57



Sleutelset

54

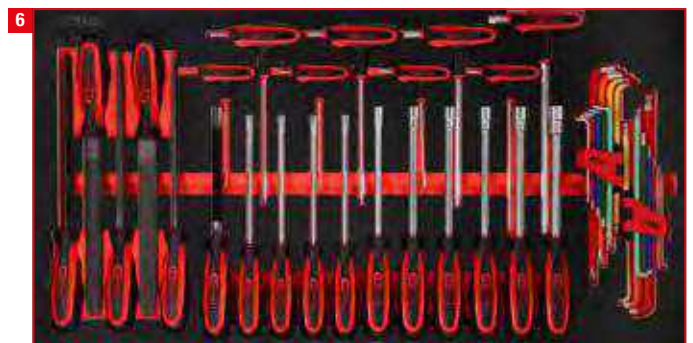

Schroevendraaijer- en vijlenset

42



Tangen- en meetgereedschapset

39



Hamer-, beitel- en kracht-doppenset

40

# HOEVEEL GEREEDSCHAPSWAGENS WILL U HEBBEN?



werkblad met 10 mm dikke anti-slipmat



afsluitbaar door ingebouwd cilinderslot



Zelfsluitend en SOFT-CLOSE-functie



Vierkant gatenpatroon voor accessoires



2 x rol- en draaiem Ø wielen: 125 mm

## ECO Line

# 449,90

ZONDER GEREEDSCHAP



**i** **1** 897.0007  
Meer informatie

Technische gegevens:	Eco Line 897.0007	Racing Line 826.0007
Totale draagkracht:	300,0 kg	350,0 kg
Belastbaarheid per schuiflade:	25,0 kg	30,0 kg
Zelfsluitend en SOFT-CLOSE-functie:	✓	✗
Velgdiameter:	125,0 mm	125,0 mm
Wielblokkeergereedschap:	✓	✓
Met centrale vergrendeling:	✓	✓
Greepvergrendeling:	✗	✓
Hoogte:	1014,0 mm	976,0 mm
Breedte:	748 mm	788 mm
Diepte:	459,0 mm	496,0 mm
Binnenmaat schuiflade:	565 x 395 mm	565 x 395 mm
met polyurethaan hoekbescherming:	✗	✓
Vierkant gatenpatroon voor accessoires:	✓	✓
Aantal schuifladen:	7	7
plaatdikte:	0,8 mm	0,9 mm
handgreep:	✓	✓
Uittrekbare lade:	100 %	90 %
Werkplek met vakjes voor kleine onderdelen:	✗	✓
Werkblad met anti-slipmat:	✓	✗
schuifladen kogelgelagerd :	✓	✓
met metalen handgreep opzij:	✓	✓

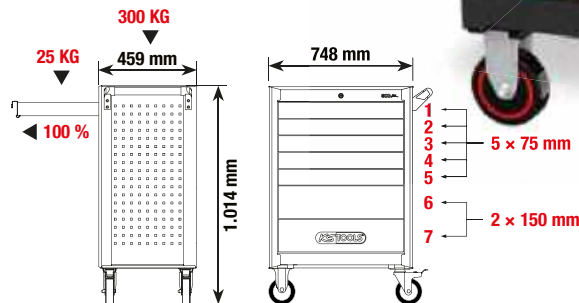

## MOEITE MET KIEZEN? KIES VOOR KWALITEIT!

## RACING Line



werkblad van ABS met vakken voor kleine onderdelen



afsluitbaar door ingebouwd cilinderslot



Afzonderlijke vergrendeling voorkomt ongewild openen



Vierkant gatenpatroon voor accessoires



2 x rol- en draaiem Ø wielen: 125 mm

# 499,90

ZONDER GEREEDSCHAP

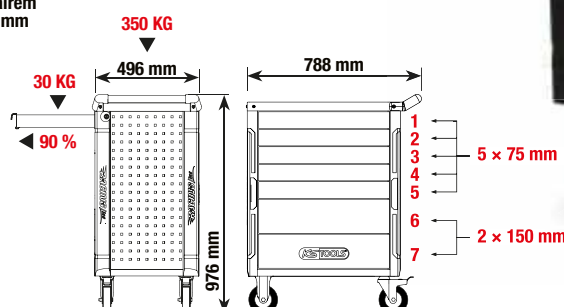

**i** **1** 826.0007  
Meer informatie

**ECO** *line*

Met 7 laden en 215-dlg  
Premium gereedschap

**679,90**

897.7215

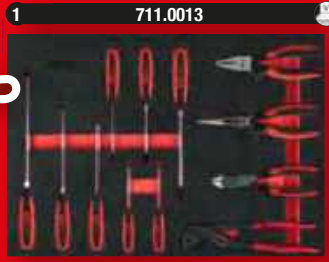

## STARTPAKKET - 215 DLG

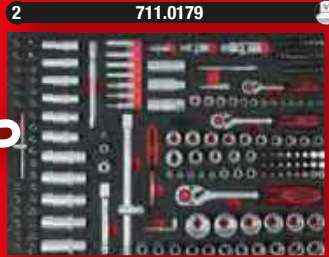
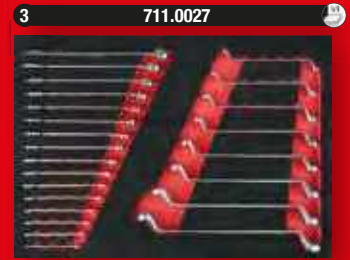

Meer informatie

**RACING** *line*

Met 7 laden en 215-dlg  
Premium gereedschap

**699,90**

826.7215



## UNIVERSEEL PAKKET - 515 DLG

**ECO** *line*

Met 7 laden en 515-dlg  
Premium gereedschap

**879,90**

897.7515



Meer informatie

**RACING** *line*

Met 7 laden en 515-dlg  
Premium gereedschap

**899,90**

826.7515



**ECO** *line*

Met 7 laden en 598-dlg  
Premium gereedschap

**1299,00**

897.7598



## POWER-PAKKET - 598 DLG

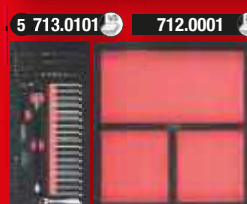

Meer informatie

**RACING** *line*

Met 7 laden en 598-dlg  
Premium gereedschap

**1349,00**

826.7598



- DIN 3110 / ISO 1085 / ISO 10102 / ISO 3318
- bekhoeck 15° gebogen
- geslepen kop
- matglans verchromd
- chroom vanadium

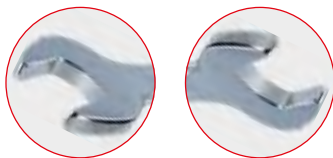

vanaf **19,90**

<b>A</b>	517.0148			6x7 · 8x9 · 10x11 · 12x13 14x15 · 16x17 · 18x19 20x22 mm	19,90 €
<b>B</b>	517.0123			6x7 · 8x9 · 10x11 · 12x13 14x15 · 16x17 · 18x19 20x22 · 21x23 · 24x27 30x32 mm	44,90 €
<b>C</b>	517.0125			6x7 · 8x9 · 10x11 · 12x13 14x15 · 16x17 · 18x19 20x22 · 21x23 · 24x27 25x28 · 30x32 mm	49,90 €



- FlankTraction-Profil
- bekhoeck 15° gebogen
- ring 15° gebogen
- gepolijste koppen
- matglans verchromd



vanaf **22,90**

<b>A</b>	517.0048			8 · 9 · 10 · 11 · 13 · 14 17 · 19 mm	22,90 €
<b>B</b>	517.0052			8 · 9 · 10 · 11 · 12 · 13 · 14 15 · 16 · 17 · 18 · 19 mm	42,90 €
<b>C</b>	517.0043			6 · 7 · 8 · 9 · 10 · 11 · 12 13 · 14 · 15 · 16 · 17 · 18 19 · 20 · 21 · 22 · 24 · 27 30 · 32 mm	109,50 €



- 12-kant
- DIN 838 / ISO 1085 / ISO 10104 / ISO 3318
- ring 75° geknikt
- dunwandig
- gepolijste koppen



vanaf **24,90**

<b>A</b>	517.0248			6x7 · 8x9 · 10x11 · 12x13 14x15 · 16x17 · 18x19 20x22 mm	24,90 €
<b>B</b>	517.0222			6x7 · 8x9 · 10x11 · 12x13 14x15 · 16x17 · 18x19 20x22 · 21x23 · 24x27 30x32 mm	49,90 €





**i** **1**  
Meer informatie

**14,90**

315 mm

22 mm

19 mm

522.1922

**i** **1**  
Meer informatie

**DE 4-IN-1  
OMKEERBARE RATEL**

10 mm

13 mm

17 mm

19 mm

**19,90**

72°

5°

503.4565

10 x 13 x 17 x 19 mm

**i** **1**  
Meer informatie

**HET MULTITALENT**

Eenhand-multifunctionele sleutel

260 mm

8 - 17 mm

14 - 32 mm

114.0055

8 · 9 · 10 · 11 · 12 · 13 · 14 · 15 · 16 · 17 · 18 · 19 · 20 · 21 · 22 · 23 · 24 · 25 · 26 · 27 · 28 · 29 · 30 · 31 · 32 mm

**33,90**

**i** **12**  
Meer informatie

72°

5°

**119,90**

503.4665

8 · 9 · 10 · 11 · 12 · 13 · 14 · 15 · 16 · 17 · 18 · 19 mm

**i** **30**  
Meer informatie

**DE ALLESKUNNER**

5/16" x 13 mm

1/2"

10 mm x 13 mm

3/8"

1/4" x 10 mm

1/4"

12 x

12 x

**168,90**

503.4960

8 · 9 · 10 · 11 · 12 · 13 · 14 · 15 · 16 · 17 · 18 · 19 mm

**i** **2**  
Meer informatie

72 5°

1/2" 305 - 445 mm

173 - 223 mm

1/4"

**VERSTELBAAR:**  
1/4" IN 4 NIVEAUS  
1/2" IN 6 NIVEAUS

**NIEUW**

**34,90**

914.1412

**i** **1**  
Meer informatie

**NIEUW**

600 MM!

460 - 600 mm

72 5°

1/2"

fase: 1 2 3 4 5 6

**24,90**

**VERSTELBAAR IN 6 STANDEN**

914.1205

**i** **1**  
Meer informatie

**49,90**

760 mm

1/2"

**MAXIMALE FLEXIBILITEIT,  
OPTIMALE CONTROLE**

918.1293

**72 5°**

**CONSISTENTE KRACHT -  
INNOVATIEVE FUNCTIE**

A

B

C

1/4"

3/8"

1/2"

**vanaf 24,90**

			Nm	↔	
A	920.1490		102	140 mm	24,90 €
B	920.3890		325	190 mm	29,90 €
C	920.1290		710	245 mm	36,50 €

102 Nm

710 Nm

72 5°

**54,90**

920.0002 **i** **2**  
Meer informatie

# DE BESTEN DIE WIJ OOIIT GEBOUWD HEBBEN!

Wij weten wat we kunnen. En omdat wij exact weten hoe goed ons Monster-ratel-assortiment is, is het voor ons vanzelfsprekend dat wij u garantie geven op elk model. Niet 2 of 3 jaar. Nee, tot wel 10 jaar! Zo is de garantie net zo premium als onze Monster-ratels!



**1** 80° <math>\leq 4.5^\circ</math> **29,90** **1/4"** **935.1490** **106 g** **125 mm** **>110 Nm**

**i** **Meer informatie**

**2** 80° <math>\leq 4.5^\circ</math> **29,90** **1/4"** **935.1495** **106 g** **125 mm** **>100 Nm**

**i** **Meer informatie**

**3** 96° <math>\leq 3.75^\circ</math> **39,90** **3/8"** **935.3890** **227 g** **199 mm** **>365 Nm**

**i** **Meer informatie**

**i**

**EGEGARANDEERD:**  
**6 MONSTERS**  
**VOOR HET LEVEN!**

**4** 100° <math>\leq 3.6^\circ</math> **49,90** **1/2"** **935.1290** **567 g** **275 mm** **>950 Nm**

**i** **Meer informatie**

**5** 100° <math>\leq 3.6^\circ</math> **69,90** **1/2"** **935.1295** **757 g** **425 mm** **>950 Nm**

**i** **Meer informatie**

**6** 100° <math>\leq 3.6^\circ</math> **99,90** **1/2"** **935.1285** **1.280 g** **406 - 635 mm** **>950 Nm**

**i** **Meer informatie**

**TELESCOPISCH**

406 431 457 482 508 533 557 582 607 635 mm

**-15%**

**NEUW**

**935.0002**

**>950 Nm**

**100° <math>\leq 3.6^\circ</math>**

**1/2"**

**+**

**80° <math>\leq 4.5^\circ</math>**

**1/4"**

**>110 Nm**

**69,90**

**i** **Meer informatie**

**2**

**i**  **9**  
Meer informatie

**Bit-dopset voor inbusschroeven, kort**

3/8" 

4 mm 5 mm 6 mm 7 mm 8 mm 9 mm 10 mm 12 mm 14 mm



**NIEUW**

**34,90**

917.4000  4 - 5 - 6 - 7 - 8 - 9 - 10 - 12 - 14 mm

**IK WIL GRAAG. MAAR KORT!**

**i**  **10**  
Meer informatie

**Bit-dopset voor Torx®-schroeven, kort**

3/8" 

T10 T15 T20 T25 T27 T30 T40 T45 T50 T55

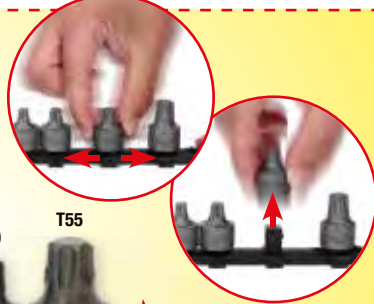



















**NIEUW**







**39,90**

917.4015  T10 - T15 - T20 - T25 - T27 - T30 - T40 - T45 - T50 - T55

**TORX TOTAAL: ALLES IN ÉÉN KOFFER**

**i**  **77**  
Meer informatie

5 x		1/4": E4 - E5 - E6 - E7 - E8
4 x		3/8": E10 - E12 - E14 - E16
4 x		1/2": E18 - E20 - E22 - E24
5 x		1/4": EPL4 - EPL5 - EPL6 - EPL7 - EPL8
4 x		3/8": EPL10 - EPL12 - EPL14 - EPL16
4 x		1/2": EPL18 - EPL20 - EPL22 - EPL24
8 x		1/4": T6 - T8 - T10 - T15 - T20 - T25 - T27 - T30
5 x		3/8": T40 - T45 - T47 - T50 - T55
2 x		1/2": T60 - T70
7 x		1/4": TB8 - TB10 - TB15 - TB20 - TB25 - TB27 - TB30
4 x		3/8": TB40 - TB45 - T50 - T55
1 x		1/2": TB60
7 x		1/4": IP8 - IP10 - IP15 - IP20 - IP25 - IP27 - IP30
3 x		3/8": IP40 - IP45 - IP50
2 x		1/2": IP55 - IP60
7 x		1/4": IPR8 - IPR10 - IPR15 - IPR20 - IPR25 - IPR27 - IPR30
3 x		3/8": IPR40 - IPR45 - IPR50
2 x		1/2": IPR55 - IPR60

-  E ✓
-  EPL ✓
-  TX ✓
-  TB ✓
-  IP ✓
-  IPR ✓

**99,90**

**NIEUW**



EVOLUTION SERIES

1/4" + 3/8" + 1/2"



911.0077

**i** **30**  
Meer informatie

EVOLUTION SERIES

**NIEUW**

**79,90**

**1/2"**

**911.4510**

55 mm		5 - 6 - 7 - 8 - 10 - 12 - 14 - 17 - 19 mm
100 mm		5 - 6 - 7 - 8 - 10 - 11 - 12 - 13 mm
140 mm		5 - 6 - 7 - 8 - 10 - 12 - 14 mm
200 mm		5 - 6 - 7 - 8 - 10 - 12 mm

**STAINLESS STEEL**

**i** **32**  
Meer informatie

EVOLUTION SERIES

**NIEUW**

**79,90**

**1/2"**

**911.4520**

55 mm		M5 - M6 - M7 - M8 - M9 - M10 - M12 - M13 - M14
100 mm		M5 - M6 - M7 - M8 - M9 - M10 - M12 - M13 - M14
140 mm		M7 - M8 - M9 - M10 - M12 - M13 - M14
200 mm		M7 - M8 - M9 - M10 - M12 - M13 - M14

**STAINLESS STEEL**

**i** **26**  
Meer informatie

EVOLUTION SERIES

**NIEUW**

**79,90**

**1/2"**

**911.4540**

55 mm		M5 - M6 - M8 - M9 - M10 - M12 - M14 - M16
100 mm		M5 - M6 - M8 - M9 - M10 - M12 - M14
140 mm		M5 - M6 - M8 - M9 - M10 - M12 - M14
200 mm		M8 - M10 - M12 - M14

**STAINLESS STEEL**

**i** **32**  
Meer informatie

EVOLUTION SERIES

**NIEUW**

**79,90**

**1/2"**

**911.4550**

55 mm		T20 - T25 - T27 - T30 - T40 - T45 - T50 - T55 - T60 - T70
100 mm		T20 - T25 - T27 - T30 - T40 - T45 - T50 - T55 - T60 - T70
140 mm		T40 - T45 - T50 - T55 - T60 - T70
200 mm		T40 - T45 - T50 - T55 - T60 - T70

**STAINLESS STEEL**

**A** matglans verchromd **B** hoogglans verchromd

**vanaf 27,90**

vernikkeld

<b>A</b>	917.0648		48	27,90 €	1/4"	
<b>B</b>	918.0648		48	29,90 €		4- 4,5 - 5 - 5,5 - 6 - 7 - 8 - 9 10 - 11 - 12 - 13 - 14 mm

**i** 20  
Meer informatie

matglans verchromd

**59,90**

1/2"

10 - 11 - 12 - 13 - 14 - 15 - 16  
17 - 18 - 19 - 20 - 21 - 22 - 24  
27 - 30 - 32 mm

911.0620

**A** matglans verchromd **B** hoogglans verchromd

**vanaf 79,90**

vernikkeld

<b>A</b>	911.0694		94	79,90 €	1/4" + 1/2"	
<b>B</b>	918.0694		94	89,90 €		4- 4,5 - 5 - 5,5 - 6 - 7 - 8 - 9 10 - 11 - 12 - 13 - 14 - 15 - 16 17 - 18 - 19 - 20 - 21 - 22 - 23 24 - 27 - 30 - 32 mm

**i** 108  
Meer informatie

matglans verchromd

**89,90**

1/4" + 1/2"

4- 4,5 - 5 - 5,5 - 6 - 7 - 8 - 9  
10 - 11 - 12 - 13 - 14 - 15 - 16  
17 - 18 - 19 - 20 - 21 - 22 - 24  
27 - 30 - 32 mm

911.0708

vernikkeld



179

Meer informatie

1/4"	4 - 4,5 - 5 - 5,5 - 6 - 7 - 8 - 9 - 10 - 11 - 12 13 - 14 mm
1/4"	4 - 5 - 6 - 7 - 8 - 9 - 10 mm
	E4 - E5 - E6 - E7 - E8
	⊖ ⊕ ⊗ ⊙ ⊛ ⊜ ⊝
3/8"	10 - 11 - 12 - 13 - 14 - 15 - 16 - 17 - 18 19 mm
3/8"	10 - 11 - 12 - 13 - 14 - 15 mm
	E10 - E11 - E12 - E14 - E16 - E1
1/2"	10 - 11 - 12 - 13 - 14 - 15 - 16 - 17 - 18 19 - 20 - 21 - 22 - 24 - 27 - 30 - 32 mm
1/2"	16 - 17 - 18 - 19 - 22 mm
	E20 - E24
1/4"	⊖ ⊕ ⊗ ⊙ ⊛ ⊜ ⊝
5/16"	⊖ ⊕ ⊗ ⊙ ⊛ ⊜ ⊝
1/4" - 3/8"	50 - 100 - 125 - 150 - 250 mm
1/2"	1,3 - 1,5 - 2 - 2,5 - 3 - 4 - 5 mm
1/4" - 3/8"	
1/2"	
1/4" - 3/8"	1/4" - 5/16"
1/2"	
1/4"	

1/4" + 3/8" + 1/2"

vernikkeld

matglans  
verchroomd

94,90

1/4"	4 - 4,5 - 5 - 5,5 - 6 - 7 - 8 - 9 - 10 - 11 12 - 13 - 14 mm
1/4"	6 - 7 - 8 - 9 - 10 - 11 - 12 - 13 - 14 15 mm
	⊖ ⊕ ⊗ ⊙ ⊛ ⊜ ⊝
3/8"	10 - 11 - 12 - 13 - 14 - 15 - 16 - 17 - 18 19 mm
3/8"	10 - 11 - 12 - 13 - 14 - 15 mm
1/2"	10 - 11 - 12 - 13 - 14 - 15 - 17 - 18 - 19 20 - 21 - 22 - 24 - 27 - 30 - 32 mm
1/2"	17 - 19 - 22 mm
	⊛
1/4"	⊖ ⊕ ⊗ ⊙ ⊛ ⊜ ⊝
5/16"	⊖ ⊕ ⊗ ⊙ ⊛ ⊜ ⊝
12 x	8 - 9 - 10 - 11 - 12 - 13 - 14 - 15 - 16 17 - 18 - 19 mm
	1,3 - 1,5 - 2 - 2,5 - 3 - 4 - 5 mm
1/4" - 3/8"	
1/2"	
1/4"	

A

matglans  
verchroomd

B

hoogglans  
verchroomd

A

917.0216



216

174,90 €

vernikkeld

B

918.0216



216

189,90 €

1/4" + 3/8" + 1/2"

A

vanaf  
174,90



<b>A</b>	911.0721			21		19 · 21 · 22 · 23 · 24 · 26 · 27 · 29 · 30 32 · 35 · 36 · 38 · 41 · 46 · 50 mm	219, <sup>90</sup> €
<b>B</b>	911.0722			21		19 · 21 · 22 · 23 · 24 · 26 · 27 · 29 · 30 32 · 35 · 36 · 38 · 41 · 46 · 50 mm	248, <sup>50</sup> €
<b>C</b>	911.0751			21		3/4" · 13/16" · 7/8" · 15/16" · 1" 1.1/16" · 1.1/8" · 1.3/16" · 1.1/4" 1.5/16 · 1.3/8" · 1.7/16" · 1.1/2" 1.5/8" · 1.3/4" · 2"	248, <sup>50</sup> €

**vanaf**  
**219,<sup>90</sup>**

			82
<b>Meer informatie</b>			
1/4"			4 - 4,5 - 5 - 5,5 - 6 - 7 - 8 - 9 - 10 - 11 12 - 13 - 14 mm
1/2"			14 - 15 - 16 - 17 - 18 - 19 - 20 - 21 - 22 24 - 27 - 30 - 32 mm
1/4"			16 - 21 mm
1/4"			
5/16"			
1/4"			
1/2"			
1/4"			150 mm
1/4"			50 - 100 - 125 - 250 mm
1/2"			
1/4"			150 mm
12 x			8 - 10 - 11 - 12 - 13 - 14 - 17 - 19 - 22 mm



**129,<sup>90</sup>**

911.0682 **1/4" + 1/2"**

matglans  
verchromd

vernikkeld



**i**  **47**  
Meer informatie



1/2"		10 - 11 - 12 - 13 - 14 - 15 - 16 - 17 18 - 19 - 20 - 21 - 22 - 24 mm
3 x		16 - 18 - 21 mm
14 x		6 - 7 - 8 - 9 - 10 - 11 - 12 - 13 - 14 15 - 16 - 17 - 18 - 19 mm
1 x		250 mm
2 x		125 - 250 mm
1 x		1/2"
5 x		3 - 5,5 - 8 mm + PH1 - PH2
1 x		T8 - T10 - T15 - T20 - T25 - T27 T30 - T40
1 x		2,5 - 3 - 4 - 5 - 6 - 7 - 8 - 10 mm
1 x		3 - 48 V
1 x		240 mm
1 x		180 mm
1 x		300 g













**149,90**

1/2"

matglans  
verchromd

940.0047



1/4"		4 - 4,5 - 5 - 5,5 - 6 - 7 - 8 - 9 - 10 11 - 12 - 13 mm
1/2"		10 - 11 - 12 - 13 - 14 - 15 - 16 - 17 19 - 20 - 21 - 22 - 24 - 27 - 30 - 32 mm
12 x		8 - 9 - 10 - 11 - 12 - 13 - 14 - 15 - 16 17 - 18 - 19 mm
2 x		1/4": 100 mm / 1/2": 125 mm
1 x		1/4" / 1/2"
7 x		3 - 4 - 5,5 - 6,5 mm + PH0 - PH1 - PH2
1 x		T8 - T10 - T15 - T20 - T25 - T27 - T30 T40 - T45 - T50
1 x		1,5 - 2 - 2,5 - 3 - 4 - 5 - 6 - 8 - 10 mm
1 x		300 g
1 x		160 mm
1 x		200 mm



1/4" + 1/2"

**A** matglans  
verchromd

**B** hoogglans  
verchromd

**A** 917.0797



174,90 €

**B** 918.0797



189,90 €



vanaf  
**174,90**





Meer informatie







150-250 V





1/4"	4 - 4,5 - 5 - 5,5 - 6 - 7 - 8 - 9 - 10 - 11 12 - 13 mm
1/2"	14 - 15 - 16 - 17 - 18 - 19 - 20 - 21 - 22 23 - 24 - 25 - 26 - 27 - 28 30 - 32 mm
12 x	6 - 7 - 8 - 9 - 10 - 11 - 12 - 13 - 14 17 - 19 - 22 mm
3 x	1/4": 50 - 100 mm / 1/2": 125 mm
1 x	1/4"
4 x	⊖ 6,5 - 8 mm ⊕ PH1 - PH2
1 x	1/4"
1 x	1/4" ⊖ ⊕ * ● ☆
1 x	150 - 250 V
1 x	250 mm
1 x	180 mm
1 x	300 g

**72**

5°

R

L

**189,90**



matglans  
verchroomd

911.0688

1/4" + 1/2"





Meer informatie

# DE ALLESKUNNER



**1**



4 x

⊖ ⊕

**2**



8 x

8 - 9 - 10 - 11 - 13  
14 - 17 - 19 mm

**3**



**4**



**369,90**

911.0727

1/4" + 1/2"

1/4"	4 - 4,5 - 5 - 5,5 - 6 - 7 8 - 9 - 10 - 11 - 12 13 - 14 mm
	⊕ * ☆
	⊖ ●
1/2"	10 - 13 - 14 - 16 - 17 18 - 19 - 20 - 22 - 24 27 - 30 - 32 mm



490 mm



400 mm

**i**  **149**  
Meer informatie



6 x 



1/4"		4 - 4,5 - 5 - 5,5 - 6 - 7 8 - 9 - 10 - 11 - 12 13 mm
1/2"		10 - 13 - 14 - 15 - 16 17 - 18 - 19 - 21 - 22 24 - 27 - 30 - 32 mm
10 x		8 - 10 - 11 - 12 - 13 14 - 15 - 17 - 19 - 22 mm



**389,90**

911.0649

1/4" + 1/2"



**VOLLEDIGE UITRUSTING?  
SLA DAN HIER UW SLAG!**

**i**  **130**  
Meer informatie





6 x   
3 x 



9 x		1,5 - 2 - 2,5 - 3 - 4 - 5 - 6 8 - 10 mm
9 x		TS10 - TS15 - TS20 - TS25 TS27 - TS30 - TS40 - TS45 TS50



1/4"		4 - 4,5 - 5 - 5,5 - 6 - 7 8 - 9 - 10 - 11 - 12 13 mm
1/2"		10 - 11 - 12 - 13 - 14 15 - 16 - 17 - 18 - 19 21 - 22 - 24 - 27 - 30 32 mm
11 x		8 - 9 - 10 - 11 - 12 13 - 14 - 16 - 17 - 19 22 mm



**449,90**



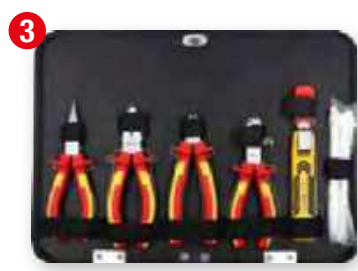

911.0630

1/4" + 1/2"

# VOOR ELEKTROMONTEURS 1



4 x   

1/4"		4 - 4,5 - 5 - 5,5 - 6 - 7 - 8 9 - 10 - 11 - 12 - 13 mm
		
1/2"		10 - 11 - 12 - 13 - 14 - 15 16 - 17 - 18 - 19 - 21 - 22 mm
10 x		8 - 10 - 11 - 12 - 13 - 14 15 - 17 - 19 - 22 mm





911.0628

1/4" + 1/2"

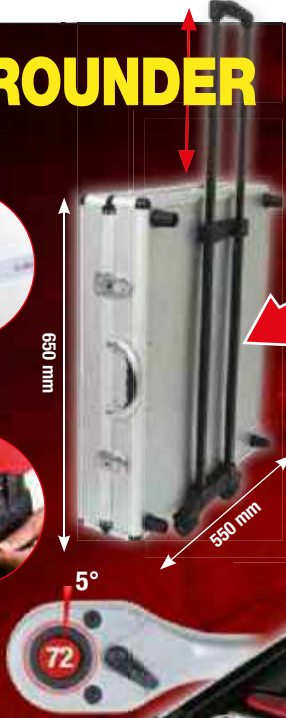
**389,90**

# DE ALLROUNDER



1/4"		4 - 5 - 6 - 7 - 8 - 9 - 11 12 - 13 mm
		
1/2"		10 - 11 - 12 - 13 - 14 - 15 - 16 17 - 18 - 19 - 21 - 22 - 24 mm
10 x		8 - 9 - 10 - 11 - 12 - 13 14 - 16 - 17 - 18 - 19 mm

911.0735

1/4" + 1/2"

**519,90**



99

Meer informatie

# DE SCHATKISTEN!



99

Meer informatie



	4 - 5 - 6 - 7 - 8 - 9 - 10 - 11 - 12 13 - 14 mm
	13 - 15 - 17 - 18 - 19 - 20 - 21 - 22 24 - 27 - 30 - 32 mm



## RATELRING-STEESLEUTEL

## RINGSTEESLEUTEL

### U KUNT KIEZEN!

8 - 9 - 10 - 11 - 12 - 13 - 14 - 15 - 16 - 17 - 18 - 19 mm

8 - 9 - 10 - 11 - 12 - 13 - 14 - 15 - 16 - 17 - 18 - 19 mm

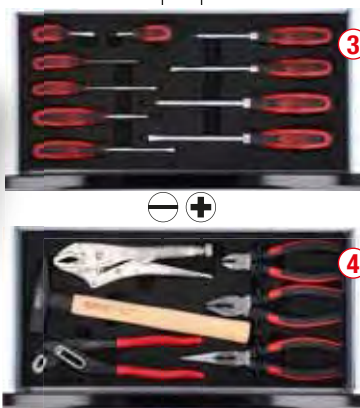

# 599,90

# 519,90

1/4" 1/2"

1/4" 1/2"



918.0100

918.0200



40

Meer informatie

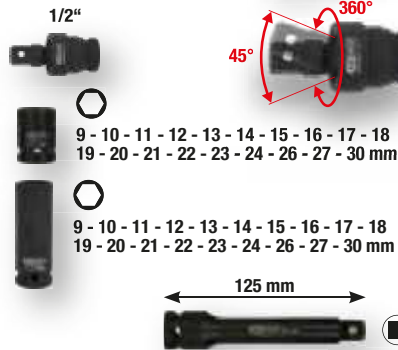

360°  
45°

9 - 10 - 11 - 12 - 13 - 14 - 15 - 16 - 17 - 18  
19 - 20 - 21 - 22 - 23 - 24 - 26 - 27 - 30 mm

9 - 10 - 11 - 12 - 13 - 14 - 15 - 16 - 17 - 18  
19 - 20 - 21 - 22 - 23 - 24 - 26 - 27 - 30 mm

125 mm

# 114,90



515.0065

1/2"





Meer informatie





vanaf  
99,<sup>90</sup>





Schaalverdeling met loop



Micrometerschaalverdeling



met Keurmerk  
**DIN EN ISO 6789**  
**Certificaat**  
Nauwkeurigheid

		Nm	Verdeling Nm	Lbf-ft		
516.1402		1/4"	1-5	0,10	0,8 - 3,6	99, <sup>90</sup> €
516.1412		1/4"	5-25	0,10	0,8 - 18	99, <sup>90</sup> €
516.1422		3/8"	10-50	0,25	4 - 37	99, <sup>90</sup> €
516.1432		1/2"	20-100	0,50	8 - 75	110, <sup>90</sup> €
516.1442		1/2"	40-200	1,00	15 - 150	110, <sup>90</sup> €
516.1472		1/2"	60-320	1,00	45 - 236	124, <sup>90</sup> €
516.1482		1/2"	80-420	1,00	60 - 310	135, <sup>90</sup> €
516.1493		3/4"	150-750	10,00	150 - 550	588, <sup>90</sup> €
516.1495		1"	200-1000	20,00	220 - 730	673, <sup>90</sup> €





Meer informatie

3 IN 1



LANG

9,<sup>90</sup>

A	151.2100			8	2 - 2,5 - 3 - 4 - 5 - 6 8 - 10 mm	9, <sup>90</sup> €
B	151.2300			8	T10 - T15 - T20 - T25 T30 - T40 - T45 - T50	9, <sup>90</sup> €





Meer informatie

22



LANG

12,<sup>90</sup>

DE BELANGRIJKSTE  
22 IN ÉÉN SET

151.4000

**i** **32**  
Meer informatie

vermikkeld

1 x		1/4"
1 x		1/4"
3 x		PH1 - PH2 - PH3
6 x		2 x PZ1 - 2 x PZ2 - 2 x PZ3
3 x		5,5 - 6,5 - 8 mm
3 x		4 - 5 - 6 mm
15 x		2 x TB10 - 3 x TB15 - 2 x TB20 3 x TB25 - 3 x TB30 - 2 x TB40

911.2060

25 mm

50 mm

**8,90**

**i** **32**  
Meer informatie

**TORION power**

+30%

1 x		1/4"
1 x		1/4"
4 x		3 - 4 - 5 - 6 mm
4 x		PH1 - 2 x PH2 - PH3
4 x		PZ1 - 2 x PZ2 - PZ3
4 x		3 - 4 - 5 - 6 mm
7 x		T10 - T15 - T20 - T25 - T27 - T30 - T40
7 x		TB10 - TB15 - TB20 - TB25 - TB27 - TB30 - TB40

911.3030

**i** **108**  
Meer informatie

**TORION power**

**29,90**

**NIEUW**

+30%

25 mm

- 6x: 4 - 5 - 6 mm
- 6x: 4 - 5 - 6 mm
- 6x: PH1 - PH2 - PH3
- 6x: PZ1 - PZ2 - PZ3
- 6x: T10 - T15 - T20 - T25 - T30 - T40

918.3108 **1/4"**

**108 BITS, DIE HET VERSCHIL MAKEN**

**i** **32**  
Meer informatie

**TORION power**

**44,90**

**32**

68 mm

100 mm

Mini

-22,1%

Mini

-49%

4 x 3 - 4 - 5 - 6 mm

4 x PH1 - 2 x PH2 - PH3

4 x PZ1 - 2 x PZ2 - PZ3

4 x 3 - 4 - 5 - 6 mm

7 x T10 - T15 - T20 - T25  
T27 - T30 - T40

7 x TB10 - TB15 - TB20 - TB25  
TB27 - TB30 - TB40

918.3010 **1/4"**

**44,90**

**i** **31**  
Meer informatie

**TORION power**

**57,90**

**31**

4 - 5 mm

PH1 - PH2 - PH3

PZ1 - PZ2 - PZ3

1,5 - 2 - 2,5 - 3 - 4 - 5 - 6  
7 - 8 mm

T6 - T7 - T8 - T9 - T10 - T15  
T20 - T25 - T27 - T30 - T40

918.3015 **1/4"**

**57,90**

**i** **24**  
Meer informatie

## KLEIN & FIJN

25 mm  
vermikkeld

# 19,90

1 x		1/4": 92 mm
1 x		1/4": 50 mm
1 x		1/4"
6 x		6 - 7 - 8 - 10 - 11 - 13 mm
2 x		PH1 - PH2
2 x		PZ1 - PZ2
2 x		4,5 - 5,5 mm
4 x		3 - 4 - 5 - 6 mm
5 x		TB10 - TB15 - TB20 - TB25 - TB30

911.2010 **1/4"**

**i** **208**  
Meer informatie

## DE ALLES-SCHROEVER!

# 39,90

1/4"		1/4": 205 mm
138 x		25 mm
29 x		50 mm
18 x		75 mm
20 x		4 - 5 - 6 - 7 - 8 - 9 - 10 - 11 - 12 - 13 mm 5/32" - 3/16" - 7/32" - 1/4" - 9/32" 5/16" - 11/32" - 3/8" - 7/16" - 1/2"
1 x		1/4": 50 mm
1 x		1/4"

911.2008 **1/4"**

**i** **7**  
Meer informatie

## HET KLEINE WONDER DER TECHNIEK!

# 9,90

## 6 IN ONE

- 4 - 5 mm
- PH1 - PH2
- PZ1 - PZ2

**NIEUW**

110 mm

**1/4"**

159.2025 **6 in 1 Mini-ratel-schroevendraaier**

**i** **13**  
Meer informatie

## 12 IN ONE

# 14,90

- 4 - 5 - 6 mm
- PH1 - PH2 - PH3
- 3 - 4 - 5 mm
- T15 - T20 - T25

240 mm

**1/4"**

159.2035 **12-in-1 ratel-bit-schroevendraaier**



**1**  
Meer informatie

**2 IN 1**

1/4" **8,90**

85 mm

OF

514.1126

**1**  
Meer informatie

1/4" **10,90**

**MET GEWICHT**

90 mm

20°

514.1136

**21**  
Meer informatie

4 mm

30 mm 165 mm

Ø 16 mm

**39,90**

500.7195

1 - 1,3 - 1,5 - 2 - 2,5 - 3 mm

PH00 - PH0 - PH1 - PH2

1,5 - 2 - 2,5 - 3 - 3,5 mm

T3 - T4 - T5 - T6 - T7

**27**  
Meer informatie

LED

1/4"

**34,90**

515.3600

**EENMAAL AANGERAAKT, VOOR ALTIJD VERKOCHT.**

**STOOLS**

max 6 Nm

max 4 Nm

max 2 Nm

4x		3,0 - 4,0 - 5,0 - 6,0 mm
4x		3,0 - 4,0 - 5,0 - 6,0 mm
5x		PH0 - PH1 - PH2 - PH3
4x		PZ0 - PZ1 - PZ2 - PZ3
4x		T10 - T15 - T20 - T25
4x		#0 - #1 - #2 - #3
1x		PH1
1x		50 mm
1x		Max. 6 Nm

3,6 V

1.600 mAh

300 rpm

USB-C

2-LED



51



Meer informatie

# DE ALLROUNDER



## 1 Boren



## 2 Reinigen



## 3 Slijpen



23x



## 4 Graveren

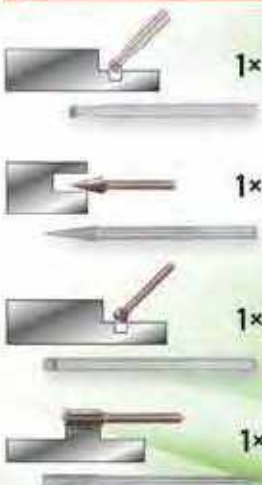

## 5 Snijden



## 6 Polijsten



eMONSTER  
Accu-multitoolset  
met 50 accessoires



# eMONSTER



50



Meer informatie

## OM LATER TE KOPEN



# 49,90

515.3990

Accessoireset, 50-dlg

# 9,90

515.3992

# DE TRANSFORMER ONDER DE SCHROEFMACHINES



**eMONSTER**

Een hoog toerental van 210 omw/min, hierdoor 5x sneller dan het handmatig aanhalen

Praktische batterij laadniveau-indicator met 3 LED's

Versterkte overbrenging



2 in 1 gereedschap met een goede balans tussen kracht en grootte, ideaal voor het werken boven het hoofd en op krappe plaatsen.

Magnetische bitopname



Verbeterd gripcomfort

1.3 Ah accu met een gebruiksduur voor **1000+** schroeven

Koppelvoorkeuze in 10 stappen instelbaar



Geïntegreerde lamp



Het doordraaien van de schroeven wordt voorkomen door automatische vergrendeling van de motor wanneer het koppel wordt overschreden.



Meer informatie

Incl. 25 bits



**39,90**

515.6500



verchromd en  
punt gebruineerd



Met profielmarkering op  
de greep

**i** **5**  
Meer informatie

159.0005

**9,90**

PH1 PH2 6,5 mm 5,5 mm 4 mm

**i** **6**  
Meer informatie

159.0030

**19,90**

T10 T15 T20 T25 T30 T40

**i** **6**  
Meer informatie

159.0040

**19,90**

TB10 TB15 TB20 TB25 TB30 TB40

**i** **39**  
Meer informatie

**50,90**

6 x		3 - 4 - 5,5 - 6,5 8 - 10 mm	7 x		2 - 2,5 - 3 - 4 - 5 6 - 8 mm
5 x		PH0 - PH1 - PH2 PH3 - PH4	7 x		TB10 - TB15 - TB20 TB25 - TB27 - TB30 TB40
4 x		PZ0 - PZ1 - PZ2 PZ3	7 x		T10 - T15 - T20 T25 - T27 - T30 T40
1 x		6 mm	1 x		1/4"
1 x		PH2	1 x		205 mm

159.0100 **1/4"**

**i** **13**  
Meer informatie

**DIE KAN WEL  
TEGEN EEN  
STOOTJE!**

**67,90**

doorlopende kling

5 x		3,5 - 5,5 - 7 - 8 - 10 mm
5 x		PH0 - PH1 - PH2 - PH3 - PH4
1 x		6 mm
1 x		PH2
1 x		1/4"

151.1150 **1/4"**

**i** **15**  
Meer informatie

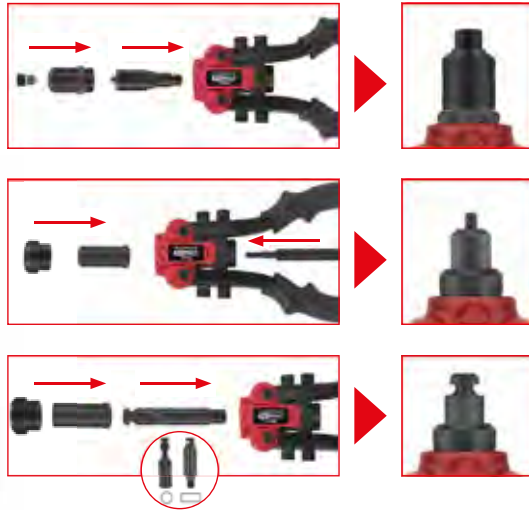

**67,90**

150.9805



		<b>A</b>	<b>B</b>
		150.9805	150.9630
	in koffer	✓	✓
	lengte mm	260	510
	knabfelschaar	✓	✗
	bediening met één of twee handen		
	M10	✓	✓
	M8	✓	✓
	M6	✓	✓
	M5	✓	✓
	M4	✓	✓
	M3	✓	✓
	Staal 4,8 mm	✓	✓
	Staal 4,0 mm	✓	✓
	Staal 3,2 mm	✓	✓
	Staal 2,4 mm	✓	✓
	Aluminium 6,4 mm	✓	✓
	Aluminium 4,8 mm	✓	✓
	Aluminium 4,0 mm	✓	✓
	Aluminium 3,2 mm	✓	✓
	Aluminium 2,4 mm	✓	✓

**i** **17**  
Meer informatie

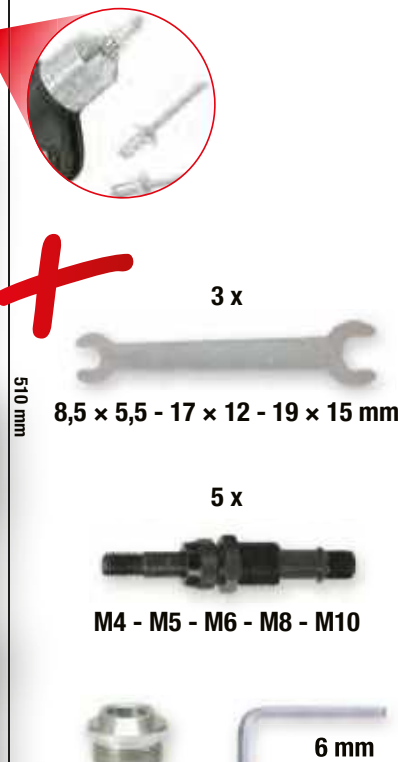

**174,90**

150.9630

**i** **1**  
Meer informatie

**vanaf 10,90**

35 - 90 mm

115.2011	175 mm	7"	10,90 €
115.2010	240 mm	10"	12,90 €
115.2012	300 mm	12"	15,90 €
115.2016	415 mm	16"	31,90 €

**i** **4**  
Meer informatie

CrV DIN 5254 A DIN 5254 B DIN 5256 C DIN 5256 D

**PREMIUM KWALITEIT!**

**i** **4**  
Meer informatie

**A** 19 - 60 mm

**B** 40 - 100 mm

**vanaf 110,90**

<b>A</b>	119.2055	19 - 60 mm	160 mm	110,90 €
<b>B</b>	119.2060	40 - 100 mm	230 mm	124,90 €

**i** **20**  
Meer informatie

**SAFETY FIRST**

60 - 100 mm + 40 - 85 mm

**49,90**

0° 15° 45° 90°

90° 45° 15° 0°

**500.1350 Borgringtangenset met vergrendeling**

# BRILJANTE PRECISIEGEREEDSCHAPPEN!

**i**  **10**  
Meer informatie

**24,90**

260 mm

300 mm

1 x		120 mm	1 x		160 mm
1 x		120 mm	3 x		PH00 - PH0 - PH1
1 x		120 mm	3 x		2,0 - 2,4 - 3,0 mm

500.7220  

**i**  **21**  
Meer informatie

**99,90**

ESD

430 mm

370 mm

2 x		125 - 130 mm	3 x		PH00 - PH0 - PH1
1 x		100 mm	4 x		1,4 - 2,0 - 2,4 - 3,0 mm
1 x		100 mm	7 x		T6 - T7 - T8 - T9 - T10 - T15 - T20
1 x		125 mm			
1 x		150 mm			
1 x		145 mm			

500.7190   

**i**  **1**  
Meer informatie

500g

met stevige, op een kraspen  
lijkende instelpunt

Ø 8,0 mm

150 - 675 mm

**5,90**

Met starre magneetkop

550.1001 2-in-1 telescoop-magneethouder met ruitensproeierreinigings- en afstelgereedschap

**i**  **1**  
Meer informatie

2,5 kg

met dunne reinigungsstift

Ø 11,0 mm

150 - 590 mm

**7,90**

met flexibele magneet-kop

550.1023 2-in-1 telescoop-magneethouder met ruitensproeierreinigings- en afstelgereedschap

**i**  **1**  
Meer informatie

**9,90**

260 - 760 mm

50 x 80 mm

max. 60 h

1 x CR 2032

LED

550.1136 Flexibele inspectiespiegel met verlichting

**i**  **5**  
Meer informatie

LED

3 x LR44

**NIEUW**

**14,90**

**5 IN 1**

Inclusief snelvergrendeling

Ø 52,0 mm

Ø 31,0 mm

90,0 x 50,0 mm

172 - 640 mm

550.1145

**i** **4**  
Meer informatie

**9,90**

45° 135° 0° 90°

550.1045

**i** **9**  
Meer informatie

**19,90**

45° 135° 0° 90° 45° 90° 0°

550.1070

**i** **1**  
Meer informatie

**8,90**

Piezo

115 mm

960.1110

**i** **1**  
Meer informatie

**19,90**

300 mm

550.1060

**i** **8**  
Meer informatie

**19,90**

95 mm

Ø 40 mm

49 mm

5 mm

Ø 1,6 mm

Ø 3,5 mm

Ø 4,5 mm

960.1265

**i** **11**  
Meer informatie

**29,90**

Piezo

200 mm

20 mm

33 mm

Ø 1,6 mm

Ø 3,5 mm

Ø 4,5 mm

Ø 5 mm

30 mm

95 mm

95 mm

Ø 40 mm

ISO BUTAN

960.1160 Micro-soldeerset



**i** **283**  
Meer informatie

**169,90**

220 mm

Ø 0,5 - 6 mm

Ø 0,5 - 6 mm

Ø 0,5 - 10 mm

Ø 6,50 / 5,41 / 1,72 mm

Ø 0,5 - 4 mm

Ø 1,0 - 3,2 mm

115.1400

**i** **1**  
Meer informatie

143 mm

**3,90**

118.0013

**i** **1**  
Meer informatie

EG II

**vanaf 2,90**

A 16 mm

B 19 mm

C 25 mm

D 25 mm

	Artikelnummer	Lengte m	Breedte mm	Prijs €
A	300.0113	3 m	16 mm	2,90 €
B	300.0114	5 m	19 mm	3,90 €
C	300.0115	5 m	25 mm	4,90 €
D	300.0116	8 m	25 mm	5,90 €

**i** **5**  
Meer informatie

Temperatuurregeling:  
1≈50°C / 2≈100°C / 3≈200°C /  
4≈350°C / 5≈550°C / 6≈650°C

260 mm

1 2 3 4 5 6

1 max. 450°C

2 max. 650°C

Toepassing:  
Verwijderen van verf, solderen van leidingen,  
krimpen van PVC, lassen en buigen van  
kunststoffen, drogen, ontdooien, enz.

**29,90**

960.1190

**i** **1**  
Meer informatie

180°

**IP 34**

15+1 m

3x 1,5 mm²

230 V  
50 Hz

1000/3000 W

10 A

**134,90**

150.4217

**i** **12**  
Meer informatie

145 mm

5,0 x 1,0 mm

5,0 x 1,0 mm

3,0 mm

3,0 mm

5,0 mm

5,0 mm

3,0 mm

2,0 mm

2,0 mm

5,0 mm

5,0 mm

5,0 mm

5,0 mm

**9,90**

140.3050

Heb 2

**i** **5**  
Meer informatie

200 mm

**29,90**

140.3000

Heb 2

**i** **1**  
Meer informatie

138 x 69 x 31 mm 342 9 V Data Hold

**19,90**

69 mm 138 mm

150.1495

**i** **1**  
Meer informatie

3 - 48 V

140 mm

**11,90**

550.1503 Polariteits- en spanningstester 3 - 48 V

**i** **1**  
Meer informatie

6 - 24 V

125 mm

**4,90**

550.1504 Proeflampje 6 - 24 V

**i** **1**  
Meer informatie

**AUTOMATIC**  
DIGITAL MULTIMETER

143 x 70 x 16 mm 119 AAA Data Hold

16 mm 143 mm 70 mm

**49,90**

NCV

USB-A USB-C

**Nr. Beschrijving**

- 1 Aan/uit-knop
- 2 Functieschakelaar
- 3 Capaciteitsschakelaar
- 4 Verlichtingsschakelaar
- 5 LCD-display
- 6 NCV-sensorbereik
- 7 Meetleidingen

Symbol	Uitleg
DC	Gelijkspanning
AC	Wisselspanning
	Indicatie voor automatische uitschakelfunctie
	Indicatie voor laag batterijniveau
	Dioden-modus
	Doorgang
	Capaciteit
%	Duty-cycle (inschakelverhouding)
HOLD	Data-hold functie
V, mV	Spanningseenheid: volt, millivolt
mF, µF, nF	Capaciteitseenheid
MΩ, KΩ, Ω	Weerstandseenheid
NCV	Contactloze spanningsinductie
Live	Controle van spanningvoerende leidingen
KHz, Hz	Frequentie-eenheid
°C/°F	Celsius/Fahrenheit

150.1765

**i** **3**  
Meer informatie

210 x 88 x 44 mm  
655  
9 V  
Data Hold

27,0 mm

**34,90**

max. meetbare kabeldiameter 29,0 mm

150.0925

**i** **1**  
Meer informatie

voor gelijk en wisselspanning

AC	6 - 50 - 120 - 230 - 400 V
DC	6 - 50 - 120 - 230 - 400 V

**23,90**

550.1501

# UNIVERSELE-SCHAKELKASTSLEUTEL

**i** **1**  
Meer informatie

**MINI**

42 mm

- 6 - 7 - 8 mm
- ▲ 9 mm
- 3 - 5 mm
- ⊕ PH 2
- 7 mm

**16,90**

130.1010

**i** **1**  
Meer informatie

71 mm

- 6 - 7 - 8 mm
- ▲ 9 mm
- 3 - 5 mm
- ⊕ PH 2
- 7 mm

**17,90**

130.1015

**i** **1**  
Meer informatie

61 mm

- 5 - 7 - 8 mm
- ▲ 9 - 10 mm
- 4 - 10 mm
- ⊕ PH 2
- 7 mm

**17,90**

130.1020

**Kabel-trekveer**

vanaf **4,90**

10 meter    20 meter

<b>A</b>	150.0960		<b>1</b>	∅ 3,0 mm 10 m	4,90 €
<b>B</b>	150.0970		<b>1</b>	∅ 4,0 mm 20 m	9,90 €

**i** **1**  
Meer informatie

**34,90**

∅ 3,0 mm

30 meter

115.1113 **Kabelintrekhelpmiddel**

**i**  **1**  
Meer informatie

**22,90**



- met moment blokkering
- maateenheden in mm en inches
- met schroefdraadtabel

300.0510

**i**  **1**  
Meer informatie

**24,90**



- met blokkeerschroef en rolverstelling
- voor buiten-, binnen-, niveau- en dieptemetingen

+/- 0,03 mm

300.0532

**i**  **1**  
Meer informatie

**INFRAROOD-THERMOMETER, -38° NAAR 520°**



**49,90**

150.3040

**i**  **4**  
Meer informatie

**56,90**



Refractometer - optisch testapparaat voor accuvloeistof en antivries

550.1290

**i**  **4**  
Meer informatie

**67,90**



Refractometer - optisch testapparaat voor accuvloeistof, antivries en AdBlue®-toevoegingen

550.1285

**i** **4**  
Meer informatie

**19,90**

11 x 115 mm  
15 x 185 mm  
18 x 320 mm  
18 x 470 mm

**911.8100 Koevoetset**

**i** **4**  
Meer informatie

**XL**

900 mm  
600 mm

0°  
45°  
75°  
90°

**179,90**

**911.8410 Wrikijzeret**

**i** **22**  
Meer informatie

**700.1200**

**Universel hydraulische trekkeret  
2 + 3-armig**

- gering afglijgevaar door automatisch sluitende klemstukken
- 8 verschillende varianten mogelijk
- extreem robuuste spindel met inductief geharde draad
- minder krachtinspanning nodig
- speciaal-gereedschapsstaal

**304,90**

20 - 35 - 85 mm  
235 mm  
185 mm  
10 t, AG 1.1/2" x 16G  
Ø max. 100 mm  
225 mm  
170 mm  
120 mm

**i** **13**  
Meer informatie

**NIEUW VOOR NOODGEVALLEN**

**79,90**

**0% ✓ 85% ✓**

Voor het losdraaien en verwijderen van vastzittende moeren met beschadigde of voor 85% "dolgedraaide" koppen

**89,90**

ring 45° geknikt

**913.3930** 8 - 9 - 10 - 11 - 12 - 13 - 14 - 15 - 16 - 17 - 18 - 19 mm **3/8"**

**517.1555** 6x7 - 8x9 - 10x11 - 12x13 - 14x15 - 16x17 - 18x19 mm

Inclusief 3/8" 1/2"



Meer informatie

- voor bouten van M3 - M18
- maakt het uitdraaien van afgebroken schroeven en bouten mogelijk
- conisch toelopende spiraal
- in stabiele kunststofbox



150.1330 Schroeven uitdraaiset

16,90

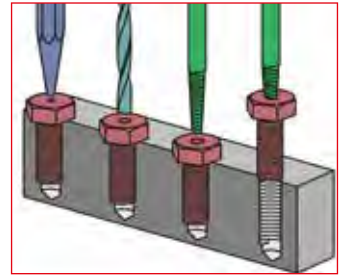

Meer informatie

TORION power

44,90

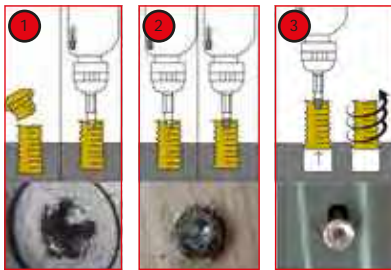

9 x		TE10 - TE15 - TE20 - TE25 - TE27 - TE30 - TE40 - TE50 - TE55
9 x		1,5 - 2 - 2,5 - 3 - 4 - 5 - 6 - 8 - 10 mm
7 x		1,5 - 2 - 2,5 - 3 - 4 - 5 - 6 mm
7 x		T10 - T15 - T20 - T25 - T27 - T30 - T40

150.7060 1/4" + 10 mm Torx- en inbusboutenuitdraaiset

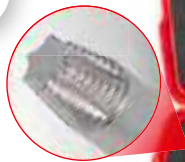

Meer informatie

Schroefdraad-uitdraaiset

- omvangrijke samenstelling van de set
- voor het verwijderen van afgebroken en beschadigde tapeinden en bouten
- geen beschadiging van de schroefdraad
- nagenoeg niet oprekken van de tapeinden door speciaal geprofileerde uitdraaistift



150.1305 M5 - M6 - M8 - M10 - M12 - M14 - M16

Führungshülse drill guide	Hülse Innen- Ø mm guide	vorböhren Ø mm pre-drilling	aufbohren re-drilling	Stift pin	Art.Nr. Stift No. Pin	Mutter D nut D	Art.Nr. Mutter nut D	Stift + Mutter pin + nut
150.0501	4,0 / 3,2	3,2	-	3,2	150.0521	SW 10	150.0511	150.0511S
150.0502	4,8 / 3,2	3,2	-	3,2	150.0521	SW 10	150.0511	150.0511S
150.0503	4,8 / 3,2	3,2	4,8	4,8	150.0522	SW 11	150.0512	150.0512S
150.0504	4,8 / 3,2	3,2	4,8	4,8	150.0522	SW 11	150.0512	150.0512S
150.0505	6,0 / 4,8	4,8	6,4	6,4	150.0523	SW 13	150.0513	150.0513S
150.0506	7,0 / 4,8	4,8	6,4	6,4	150.0523	SW 13	150.0513	150.0513S
150.0507	7,0 / 4,8	4,8	8,0	8,0	150.0524	SW 14	150.0514	150.0514S
150.0508	7,0 / 4,8	4,8	8,7	8,7	150.0525	SW 17	150.0515	150.0515S
150.0509	9,0 / 6,5	6,4	8,7	8,7	150.0525	SW 17	150.0515	150.0515S
150.0510	9,5 / 6,5	6,4	8,7	8,7	150.0525	SW 17	150.0515	150.0515S

39,90

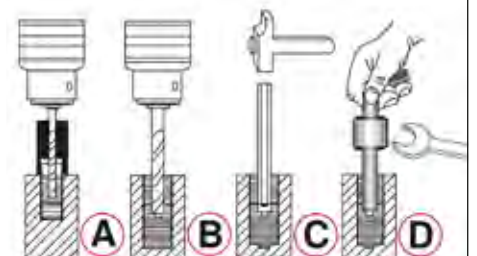



Meer informatie

### Tapeind-uitdraaiset

- Buitenzeskantaandrijving 21,0 mm
- met rechts- en linksspanfunctie
- goede grip door 3 klembussen
- in en uitdraaien zonder twee moeren op het tapeind te hoeven draaien
- ook voor langere tapeinden geschikt - omdat de schacht hol is

# 49,90



152.1101 M5 - M6 - M7 - M8 - M10 - M12 - M14



Meer informatie

### HSS Co schroefdraad-snijgereedschapset in cassette

- universeel inzetbaar
- rechte tappen
- met verstelbare snij-ijzer- en tappenhouder
- inclusief draadmal en schroevendraaier
- hoogwaardig staal van kobaltlegering



## HET ONTBREEKT AAN NIETS



33 x		M3 - M4 - M5 - M6 - M8 - M10 - M12 M14 - M15 - M18 - M20
11 x		M3 - M4 - M5 - M6 - M8 - M10 - M12 M14 - M15 - M18 - M20
6 x		M3-M4 - M4,5-M6 - M7-M9 - M10-M11 - M12-M14 - M16-M20
2 x		M1-M10 - M5-M20

# 499,90

331.0754



Meer informatie

### LEDEREEN DRAAGT HET GRAAG!

# 24,90



EN388



4131X

Micro-gebreid

	Maat	Verpakking
310.0490	7	12 paar
310.0491	8	12 paar
310.0470	9	12 paar
310.0475	10	12 paar
310.0480	11	12 paar



Meer informatie

# 3,90



310.0120

**FLAME-DESIGN**

Meer informatie

**49,90**

310.0155

**STEEL-DESIGN**

Meer informatie

**49,90**

310.0195

**EN 379 1/1/1/2**      **EN 175**

**Technische gegevens:**

Kleurkeuze:	traploos regelbaar van DIN 9-13 Standaard lichtafstelling: DIN 4
Omschakelreactietijd:	1/25.000 s 0,2 - 0,8 s (instelbaar)
UV/IR bescherming:	volgens EN 169 / tot DIN 16
Bedrijfstemperatuur:	-5°C tot +55°C
Bewaartemperatuur:	-20°C tot +70°C
Stroomvoorzorging:	d.m.v. solarcellen
Hoogte:	220 mm
Breedte:	200 mm
Lengte:	295 mm
Gewicht:	480 g
Afmetingen cassette:	110 x 90 x 9 mm
Kijkglas:	92 x 42 mm

**Universele pompverstuiver**

Meer informatie

- van hoogwaardige polyethyleen
- Voor diverse chemicaliën, zoals bijv. spoel-, oplos- en reinigingsmiddelen, etc.
- Ongeschikt voor remmenreiniger
- Sproeikop van messing, verstelbaar en afsluitbaar
- Afdichtingen van Viton®
- geschikt om boven je hoofd te werken

PE VITON

360°

**Ongeschikt voor remmenreiniger**

**vanaf 14,90**

150.8251	1 L	14,90 €
150.8252	2 L	19,90 €

**NIEUW**

Meer informatie

0,25 L max. 8 bar (116 psi) 60°C 140°F

115 mm

250 mm

0,25 L

**Aluminium**

**Speciaal voor remmenreiniger**

**49,90**

150.8272



**i** **16**  
Meer informatie

**EVOLUTION SERIES**

**Vlakschraper-set**

- geschikt voor het verwijderen van stickers, lijm- en kitresten
- eenvoudige wissel van het mes door het losdraaien van de spanner
- praktische set door de verwisselbare mes-modellen
- bijzonder geschikt voor verschillende doeleinden door de verschillende messen
- Schraper met 2-componenten greep

Vervangingsklingen: 907.2202, 907.2203, 907.2204, 907.2205, 907.2206

**NIEUW**

5x 12 mm  
5x 16 mm  
5x 20 mm

145 mm

**12,90**

907.2255

**i** **27**  
Meer informatie

**Messen-schraper-set**

5x 19 mm

145 mm

5x 12 mm  
5x 16 mm  
5x 16 mm  
5x 20 mm

145 mm

**19,90**

907.2200

**Stickerschraper**

**A** **B**

110 mm 145 mm

**vanaf 3,90**

<b>A</b>	907.2240			1	110 x 39 mm	3,90 €
<b>B</b>	907.2242			1	145 x 40 mm	4,90 €

**Klapmes met vergrendeling**

**A** **B**

190 mm 220 mm

**vanaf 10,90**

<b>A</b>	907.2105			1	190 x 25 mm	10,90 €
<b>B</b>	907.2190			1	220 x 28 mm	11,90 €

**i** **2**  
Meer informatie

**14,90**

155 mm 97 mm

**Klapmessenset**

907.2172

**i** **3**  
Meer informatie

**39,90**

250 mm

**Hefboom-blikdoorgangsscharenset**

118.0050





Meer informatie



6 dimbare  
Mini-LED'S

Ø  
3,9 mm

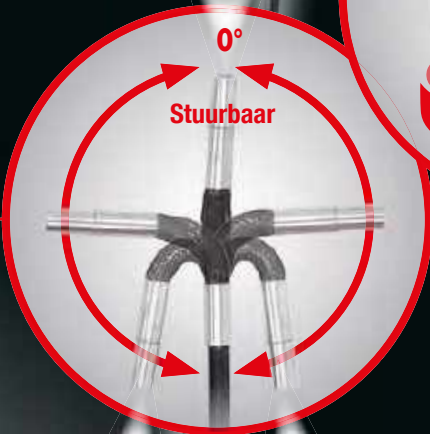

Stuurbaar

180°

180°



draaibaar

360°



Aansluiting sonde



USB 2.0



microSD



3000 mAh  
Li-polymer



IP  
67



AVI  
1280 x 720



JPG



150 mm



-10°/+60°C



NIEUW

449,<sup>90</sup>

+ 32 GB

550.7550 HD-videoscoopset met Ø 3,9 mm 180 en 0° HD-frontcamera-sonde, flexibele PVC-huls





Ø 12 - 35 MM

104.5060 **Inox** **Steel**

Ratel-pijpsnijder

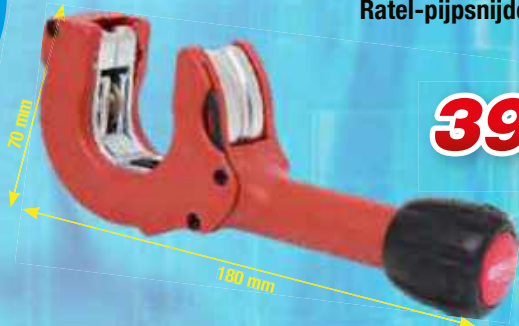

39,<sup>90</sup>



Ø 28 - 67 MM

104.5050 **Inox** **Steel**

Ratel-pijpsnijder



129,<sup>90</sup>

116.1050



**FUGENFIX**™



7,<sup>90</sup>

FUGENFIX Kitschraper- en afwerkset



903.3300

Schroefdraad-snijset 3/8" - 1.1/4"

3/8"  
1/2"  
3/4"  
1"  
1.1/4"

79,<sup>90</sup>



116.2000



**57,90**

Afvoerfix

130.3000 1/2"

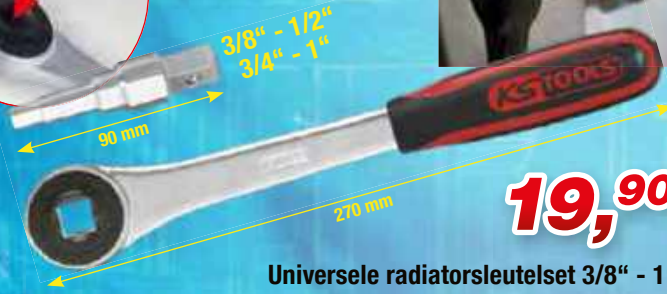

**19,90**

Universele radiatorsleutelset 3/8\" - 1"

903.5902

- vlamtemperatuur ca. 1.700°
- werktemperatuur ca. 650°
- solderen tot max. Ø 22 mm
- levering zonder gaspatroon
- gebruik alleen met standaard hoogwaardige branders
- behuizing van kunststof



Piezo



**24,90**

Universele brander met piezo ontsteking

907.2113

Japanse trekzaag, dubbel getand



**17,90**



850.0300

SMARTBAG universele- gereedschaptas

**73,90**

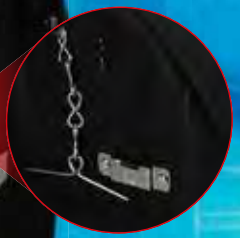

**NIEUW**



### Compacte en robuuste constructie:

Door hoogwaardige kunststoffen en stevige schroefverbindingen biedt de accu bijzonder goede bescherming tegen mechanische invloeden.



### 18V eMONSTER accu-systeem

Het krachtige 18V eMONSTER accu-systeem combineert een reeks professionele draadloze elektrische gereedschappen. Alle apparaten kunnen worden gebruikt met één accu-systeem. Het assortiment is breed en wordt voortdurend uitgebreid. Elk nieuw apparaat kan ook met dit accu-systeem worden gebruikt. Zo kun je dit accu-systeem jarenlang gebruiken en uitbreiden met eMONSTER 18V-apparaten - je blijft in een accufamilie.



### Warmteafvoer:

Door een geribde constructie wordt de warmte net als bij een koelelement geleid naar de omgevingslucht.



### Geoptimaliseerde celplaatsing:

Door de pijpconstructie worden de individuele cellen in het warmtegeleidende kunststof geschoven. Zo ontstaat een stevig contact tussen de cel en het warmtegeleidende kunststof. Er is geen isolerende luchtlaag meer aanwezig, die de warmtegeleiding vermindert.



### Actieve luchtkoeling:

(alleen bij 8,0 Ah snellaadapparaat) De geïntegreerde ventilator van het 8,0 A snellaadapparaat, levert tijdens het laadproces doorlopend frisse lucht, zodat de in de accu en het laadapparaat ontstane warmte zoveel mogelijk wordt gereduceerd. Door deze besparende laadprocedure wordt levensduur van de accu duidelijk langer.



### Extra bescherming voor een lange levensduur van de accu:

- Overspanningsbeveiliging**
  - Bescherming tegen ontoelaatbaar hoge spanningsbronnen
- Laagspanningsbeveiliging**
  - Bescherming tegen diepontlading tijdens gebruik
- Temperatuurmanagement**
  - Samenspel van machine en accu, voor het verhinderen van een overbelasting van de accu





### eMONSTER brushless accuschroef-/boormachineset

## MINI



# 159,90

Aanhaalmoment max: 40 Nm  
Aandrijving: 10 mm snelspanboorkop

515.6400



### eMONSTER brushless acculagschroef-/boormachineset



# 189,90

Aanhaalmoment max: 60 Nm  
Aandrijving: Metaal 13 mm Röhmsnelspanboorkop

515.6300

### INCLUSIEF



Accuspanning: 18,0 V  
Max. laadstroom: 3 A

Accuspanning: 18,0 V  
Accutechnologie: Lithium-ionen  
Accucapaciteit: 2,0 Ah

Levering incl. twee 2,0 Ah accu's en 3 A snellaadapparaat

### INCLUSIEF



Accuspanning: 18,0 V  
Max. laadstroom: 8 A

Accuspanning: 18,0 V  
Accutechnologie: Lithium-ionen  
Accucapaciteit: 4,0 Ah

Levering incl. twee 4,0 Ah accu's en 8 A snellaadapparaat



### eMONSTER 1/2" brushless accu-slagschroefmachineset



# 269,90

max. losdraai-moment: 690 Nm  
Aandrijving: 1/2"

515.6100



### eMONSTER brushless haakse accuslijpmachineset



# 299,90

Toerental: 9000 Ommw/min  
Trillingsversnelling: < 4,831 m/s<sup>2</sup>  
3,371 m/s<sup>2</sup>

515.6200



### 1/4" TORSIONpower bit-set in eMONSTER-accu-design, 32-dlg



# 9,90

515.6932

1 x		1/4"
1 x		1/4"
4 x		3 - 4 - 5 - 6 mm
4 x		PH1 - 2 x PH2 - PH3
4 x		PZ1 - 2 x PZ2 - PZ3
4 x		3 - 4 - 5 - 6 mm
7 x		T10 - T15 - T20 - T25 - T27 - T30 - T40
7 x		TB10 - TB15 - TB20 - TB25 - TB27 - TB30 - TB40



# HIER GEBEURT HET SLAG VOOR SLAG!

**1.390 N·m**

1/2"

90 mm

115 mm

515.1150

1  **199,90**

**1.390 N·m**

1/2"

95 mm

110 mm

515.1270

2  **149,90**

**1.084 N·m**

1/2"

115 mm

160 mm

515.1315

3  **69,90**

**1.600 N·m**

1/2"

170 mm

113 mm

515.1200

4  **69,90**

**2.000 N·m**

3/4"

170 mm

185 mm

515.3400

5  **124,90**

**1.690 N·m**

1/2" 3/4"

175 mm

200 mm

515.1210

6  **149,90**

7  **189,90**

**3.405 N·m**

3/4" 1"

195 mm

250 mm

515.3250

9  **849,90**

11  **849,90**

**3.405 N·m**

3/4" 1"

195 mm

250 mm

515.3260

10  **904,90**

12  **904,90**

													
		MAX Nm	U/min	m/s <sup>2</sup>	dB(A)	dB(A)	U/min	PT				kg	
1	515.1150	1/2"	1390	10.800	<9,18	102,0	113,0	135	1/4"	-	✓	-	1,88
2	515.1270	1/2"	1390	10.000	<9,18	102,0	113,0	135	1/4"	-	✓	-	1,3
3	515.1315	1/2"	1084	9000	<10,36	106,0	115,0	169	1/4"	-	✓	-	1,2
4	515.1200	1/2"	1600	8500	<17,5	89,9	100,9	169	1/4"	✓	-	-	2,1
5	515.3400	3/4"	2000	8500	<17,25	91,0	100,9	196	1/4"	✓	✓	-	2,2
6	515.1210	1/2"	1690	7930	<17,9	87,0	98,0	178	1/4"	✓	✓	-	2,1
7	515.3785	3/4"	1690	7930	<13,56	88,0	104,0	178	1/4"	✓	✓	-	2,2
8	512.0002	1/2"	2300	8500	<8,69	99,7	110,9	244	1/4"	✓	✓	✓	1,6
9	515.3250	3/4"	3405	6200	<12,57	115,5	104,5	283	1/2"	✓	✓	-	6,7
10	515.3260	3/4"	3405	6200	<12,88	115,5	104,5	283	1/2"	✓	✓	-	7,7
11	515.3270	1"	3405	6200	<12,57	115,5	104,5	283	1/2"	✓	✓	-	6,7
12	515.3280	1"	3405	6200	<12,88	115,5	104,5	283	1/2"	✓	✓	-	7,8

 hoogwaardig Twin-Hammer-Clutch systeem

 Hoogwaardig Jumbo-hammerslagmechanisme

 BITURBO technologie

Alle prijzen in EUR excl. BTW gelden tot en met 30-09-2024





**i** **1**  
Meer informatie

**Vetopbrengst: telkens een slag per levering**



200 mm  
400 g  
400 mm

**66,50**

**515.3900** Perslucht-vetspuit voor vettransport met slagen

**i** **1**  
Meer informatie

**vanaf 24,90**



**PU** ✓

	Ø				
515.3330	6,0 mm	G1/4"	AG	8,0 m	24,90 €
515.3335	8,0 mm	G1/4"	AG	15,0 m	34,90 €
515.3340	10,0 mm	G3/8"	AG	15,0 m	39,90 €

**i** **1**  
Meer informatie

**9,90**

Regelbaar

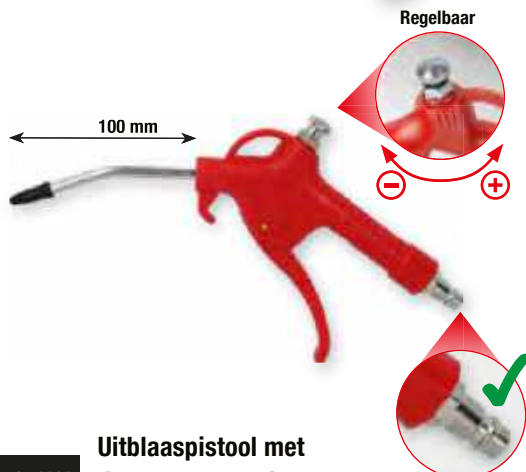

100 mm

**515.1901** Uitblaaspistool met doorstroomregelaar

**i** **3**  
Meer informatie

**19,90**



510 mm  
330 mm  
95 mm

**515.1921** Uitblaaspistool-set

Oprolautomaat voor luchtslang



15 m  
1,5 m

180°

**515.3440**

**i** **1**  
Meer informatie

**119,90**

➔ **Ø 10 MM X 15 M**

**A**

Technische gegevens:

Binnendiameter slang:	10,0 mm
max. Druk:	20,0 bar
Draad aansluiting:	1/4"

**515.3445**

**i** **1**  
Meer informatie

**179,90**

➔ **Ø 13 MM X 15 M**

**B**

Technische gegevens:

Binnendiameter slang:	13,0 mm
max. Druk:	20,0 bar
Draad aansluiting:	3/8"

**i** **1**  
Meer informatie

**vanaf**  
**11,90**

	↔		
<b>A</b>	500.8040	480 mm	11,90 €
<b>B</b>	500.8045	1.150 mm	39,90 €

**i** **1**  
Meer informatie

**1**  
**49,90**

500.8020

**i** **1**  
Meer informatie

**2**  
**59,90**

500.8030

**i** **1**  
Meer informatie

**HOOG BELASTBAAR  
TOT 135 KG**

**3**  
**69,90**

500.8004

**i** **1**  
Meer informatie

**4**  
**69,90**

500.8011

**i** **1**  
Meer informatie

**6**  
**99,90**

500.8000

	<b>1</b>	<b>2</b>	<b>3</b>	<b>4</b>	<b>5</b>	<b>6</b>
Technische gegevens:	500.8020	500.8030	500.8004	500.8011	500.8090	500.8000
Kleur	rood	rood	rood	rood	rood	rood
Materiaal	Stalen buis	Metaal	Metaal	Metaal	kunststof	Metaal
Aantal draaiwielen	4	5	5	6	6	6
verrijdbaar	✓	✓	✓	✓	✓	✓
Bandentype	Kunststof	Kunststof	Rubber	Kunststof	Kunststof	Kunststof
gevoerd	✓	✓	✓	✓	✗	✓
Camerascherming	✗	✓	✓	✓	✗	✓
Inhoud verpakking	1	1	1	1	1	1
Totale lengte L in mm	365,0 mm	370,0 mm	360,0 mm	1040,0 mm	1030,0 mm	1200,0 mm
Breedte B	360,0 mm	370,0 mm	360,0 mm	490,0 mm	480,0 mm	420,0 mm
Hoogte H	360,0 mm	420,0 - 540,0 mm	463,0 - 580,0 mm	85,0 - 400,0 mm	115,0 mm	145,0 - 510,0 mm
Totale draagkracht kg	90 kg	90 kg	135 kg	90 kg	120 kg	90 kg

**i** **1**  
Meer informatie

**DE LICHTSTE**

**5**  
**67,90**

500.8090

**i**  **3**  
Meer informatie

**Geniaal flexibel**

**NEUW**

**44,90**

**500.8077 Gereedschapopbergset van siliconen**

**1** 53 x 29,5 x 3,2 cm

**2** 25,5 x 23,3 x 2,4 cm

**3** 27,5 x 14,5 x 2,4 cm

**i**  **1**  
Meer informatie

- met stroef profiel op de loopplank
- met groter plateau voor veilig gebruik
- rubber doppen in de poten beschermen het plateau en ondergrond

**99,90**

**800.0960 Aluminium veiligheids plateau**

960 mm, 300 mm, 495 mm

**VOOR UW VEILIGHEID**

**TÜV SÜD** (max. 150 kg)

**GETEST!**

**i**  **1**  
Meer informatie

- met ribbel-profiel op de trede
- staat stabiel door schuin geplaatste poten
- inklapbaar en daarom ruimtebesparend

**54,90**

**800.0965 Aluminium uitzettrap**

600 mm, 440 mm, 620 mm

**VOOR UW VEILIGHEID**

**TÜV SÜD** (max. 150 kg)

**GETEST!**

Meer informatie

**MAXIMAAL WERKOPPERVLAK**

**1199,90**



840 mm

2000mm

680 mm

XXL

865.0201

**XXL-werkbank met 3 schuifladen en 1 deur**

Meer informatie

**KLEIN EN GROOT TEGELIJK!**

**179,90**



257 - 1380 mm

845 - 1320 mm

257 - 1380 mm

500.8100

**Universele multifunctionele telescoopwagen met rollen**

Meer informatie

Ø 440 mm

**3** 5000 rpm, 57 dB, 4,9 m/s, 56,9 W

**2** 4500 rpm, 51,5 dB, 4,3 m/s, 53 W

**1** 4000 rpm, 48 dB, 3,5 m/s, 49 W

180°

**NIEUW**

**49,90**

✓ **EXTREEM STIL**

✓ **ULTRALICHT**

**< 3,5 KG**

610 mm

570 mm

999.2000

**Werkplaatsventilator, 70 Watt**

Meer informatie

360°

**Parallel bankschroef**

360° met draaiplaat

**vanaf 165,90**

bekken en aambeeld inductief gehard

914.0004	120 mm	4"	165,90 €
914.0005	140 mm	5"	178,90 €
914.0006	160 mm	6"	189,90 €
914.0008	200 mm	8"	229,90 €

**i**

Meer informatie

max. 8 bar (116 PSI)	60° C 140° F

**19,90**

**1** Water    **2** Detergent    **3**

Max. 40° C    Max.

**4**    **5**    Switch    Lock

150.8271

**Drukpompschuimspuit (schuimer)**

**i**

Meer informatie

**84,90**

350 mm

650 mm

**500.8013**    **Verrijdbare kruk**

**i**

Meer informatie

6,3 bar	96 L/min
92 dbA	1/4" PT

**39,90**

145 mm    3/8" - Ø 10 mm

**515.5090**    **Pneumatisch zuigpistool**

Zuigen    Blazen

**i** **1**  
Meer informatie

Ø 90 mm

15 mm

M8

**5,90**

515.1243 Caramelschijf



**i** **1**  
Meer informatie

24 mm

Ø 100 mm

M8

**15,90**

515.1247 Caramelschijf met lamellen

**i** **6**  
Meer informatie

**SETPRIJS = 6x**

515.1285

**29,90**



**i** **6**  
Meer informatie

**SETPRIJS = 6x**

515.1366

**89,90**

**i** **1**  
Meer informatie

515.1980

**141,90**

Pneumatisch reinigingspistool

ON - OFF

Regelbaar

Industrieel kogellager

360°

30°

1/4" NPT

8000

160 Liter

6,3 bar (90psi)

3/8"-10 mm

<3,90 min⁻²

106 dbA

95 dbA

1000 ml

**OPTIONEEL**

**i** **1**  
Meer informatie

515.1983

Borstelopzetstuk

**5,90**

**i** **1**  
Meer informatie

515.1986

Borstel-kwast

**5,90**

**i** **6**  
Meer informatie

**29,90**

510 mm

4 mm  
8 mm  
10 mm

4 mm  
8 mm  
10 mm

245 mm

**140.2370** **Clip-verwijderset**

**i** **11**  
Meer informatie

**19,90**

180 mm 200 mm 200 mm 200 mm 210 mm

160 mm 200 mm 200 mm 180 mm 200 mm 200 mm

**911.8205** **MASTER Kunststof wigset**

**i** **1**   
Meer informatie

- verwijdert geuren en desinfecteert het voertuiginterieur
- automatische uitschakeling in geurverwijderingsmodus na 60 minuten
- werkt zonder chemische toevoegingen, waardoor een reiniging zonder reststoffen gegarandeerd is
- laat zelfs op gevoelige oppervlakken geen sporen achter
- verwijdert schimmel, bacteriën en meeldauw

173 mm

49 mm

122 mm

**79,90**

**550.1183** **Plasma-luchtzuiveraar met ionisator-techniek**

**i** **1**  
Meer informatie

- Zeer geschikt voor het reinigen van dunne buizen, slangen of afvoeren
- aan beide kanten te gebruiken
- Flexibele RVS-slang
- Nylon borstels

**3,90** **NIEUW**

Ø 16 mm

Ø 22 mm

**150.1762** **Flexibele reinigingsborstel**

**i** **7**  
Meer informatie

Ø 0 - 38 mm

Ø 0 - 48,5 mm

Ø 0 - 65 mm

Ø 0 - 30 mm

Ø 0 - 45 mm

Ø 0 - 45 mm

Ø 0 - 60 mm

**79,90**

**115.1055** **Automobil slangklemtangenset**



**i** **3**  
Meer informatie

**9,90**

Ø 15 mm    Ø 30 mm    Ø 60 mm

150 mm    180 mm    250 mm

115.5050

**i** **3**  
Meer informatie

Ø 15 mm    Ø 35 mm    Ø 23 mm

155 mm    255 mm    165 mm

**12,90**

115.5055

**i** **1**  
Meer informatie

**14,90**

Afzuig- en vulhandpomp

150.9221

**i** **1**  
Meer informatie

**19,90**

100 mm

Speciale 3/8" steeksleutel voor zuigbuis-schroefkoppelingen

150.2519

**i** **1**  
Meer informatie

**19,90**

12,0 V    5 A    60 W

Richtung Direction

150.2620

PETROL    DIESEL    OIL

Elektrische olieaanzuig- en transferpomp

150.2620

**i** **1**  
Meer informatie

**4,90**

Wisseldop voor 30 - 45 mm en 60 - 80 mm slangklemmen

**NIEUW**

30 mm

Speciale 2-in-1 dopsleutel voor slangklemmen met 3-puntsprofiel

115.0915

**i** **1**  
Meer informatie

**12,90**

**NIEUW**

1/2"

108 mm

Radiatorop-demontagegereedschap voor VAG

150.1919





25

Meer informatie









0 - 2,5 bar



max. 76 cm



0 - 200 °C  
0 - 400 °F



1600 mm



R123  
R124



R123  
R125



#1



#2



#3



M50 x 2,5



M42 x 3



M58 x 3



M62 x 3



M48 x 4



M45 x 3



M50 x 2,5



M60 x 4



M52 x 3



M48 x 2,5



M42 x 2,5



M50 x 3



M46 x 3



M34 x 2,5



75 mm

# 179,<sup>90</sup>

**MASTER**  
150.1930 koelsysteem-diagnose-serviceset







1

Meer informatie

**Koppeling 7,2 mm naar 4,4 mm**



7,2 mm



4,4 mm

**NIEUW**

# 19,<sup>90</sup>

150.1936







1

Meer informatie

**Koppeling 4,4 mm naar 7,2 mm**



4,4 mm



7,2 mm

**NIEUW**

# 24,<sup>90</sup>

150.1937



**i**  **8**  
Meer informatie

250 ml

**99,90**

150.1910 CO2-cilinderkop-lekkagetestset

OPTIONEEL BIJ TE KOPEN

**14,90**

150.1914

**i**  **3**  
Meer informatie

**GENIAAL FLEXIBEL**

53 x 29,5 x 3,2 cm

1

2

3

25,5 x 23,3 x 2,4 cm

27,5 x 14,5 x 2,4 cm

**NIEUW**

**44,90**

500.8077 Gereedschapopbergset van siliconen

**i** 2  
Meer informatie

**EcoBoost**

**NIEUW**

180 mm + 215 mm

14 mm + 16 mm

**24,90**

**VOOR FORD ECOBOOST MOTOREN 1,0 LITER**

**VOOR FORD ECOBOOST MOTOREN 1,5 LITER**



517.1135 **Bougiedopset voor EcoBoost-motoren**

**i** 2  
Meer informatie

M20 x 1.5 + M22 x 1.5

27 mm

13 mm

Met 6 snijtanden voor ideale centering

Met reinigingsgroeven in geleidingspen

**179,90**

150.2540 **Schroefdraadtapset met geleidepen voor sensoren**



**GENIALE PROBLEEMOPLOSSER**

**NIEUW**

**i** 1  
Meer informatie

**Schroefdraadtap met geleidingspen**

- Voor het opsnijden van verroeste en beschadigde speciale schroefdraad

13 mm

Met 6 snijtanden voor ideale centering

Met reinigingsgroeven in geleidingspen

**99,90**

			L1	L2			
<b>A</b>	150.2541	Voor temperatuursensoren	M12 x 1,25	55 mm	33 mm	13 mm	99,90 €
<b>B</b>	150.2542	Voor temperatuursensoren	M14 x 1,5	45 mm	30 mm	13 mm	99,90 €
<b>C</b>	150.2543	Voor lambdasonden	M18 x 1,5	42 mm	27 mm	13 mm	99,90 €
<b>D</b>	150.2544	Voor NOX-sensoren	M20 x 1,5	50 mm	27 mm	13 mm	99,90 €
<b>E</b>	150.2546	Voor roetfiltersensoren	M22 x 1,5	50 mm	27 mm	13 mm	99,90 €



**i**  **1**  
Meer informatie

**19,90**



**1** **2**

**Bobinetrekker voor staaftobines**

**500.7505**



**i**  **7**  
Meer informatie

**VOOR VAG EN OPEL MOTOREN**

**69,90**



**1** **2** **3** **4** **5** **6** **7**

**Bobinetrekset met T-greep voor VAG en Opel motoren**

**500.7570**



**i**  **7**  
Meer informatie

**120 ml** **120 ml**



**6x10**  
**6x6**  
**6x8**  
**6x4**  
**600 mm**  
**Ø 6x9 mm**

**169,90**

**Druk- en vacuümpompset**

**150.1900**



**i**  **24**  
Meer informatie



**49,90**

**Universele set montagegereedschap voor keerringen en borgringen**

**700.1280**



**i** **1**  
Meer informatie

max. 165 mm

M 12 x 75 mm

30 mm

40-165 mm

**39,90**

**Universele-riemschijftrekker**  
2-armig Ø 40-165 mm

150.3170

**i** **1**  
Meer informatie

**NIEUW**

1/4"

13 mm

Ø 3,0 mm

8 - 25 mm

- Voor het spannen en ontspannen van de tandriemsparol
- verstelbaar, universeel te gebruiken
- binnenvierkantaandrijving volgens DIN 3120 / ISO 1174
- met buitenzekantaandrijving 13,0 mm
- gefosfateerd

**19,90**

**Universele pensleutel voor tandriemsparol, verstelbaar**

150.3046

**i** **1**  
Meer informatie

Toepassingsgebieden: Citroën, Peugeot, Opel und Toyota met 1,0 en 1,2 benzinemotoren (motorcode: ZMZ (EB0F / EBO) / HMO1 (1PP) / HMV, HMZ (EB2) / HMZ (EB2 / EB2F) / HMT (EB2D) / HMO (EB2D) / HNZ (EB2DT) / HNY (EB2DTS) / HMV (EB2M) / HMY (EB2M) / B12XE (EB2F) / D12XE (EB2FA) / B12XHL (EB2DT) / D12XHL, F12XHL (EB2ADT) / B12XHT (EB2DTS) / D12XHT, F12XHT (EB2ADTS)

**9,90**

**Tandriem testgereedschap voor PSA**

400.2118

**i** **1**  
Meer informatie

M 15 x 1,5 x 71 mm

17 mm

27 mm

70 mm

**34,90**

**Universele trekker voor riempoelies, 3-armig**

150.3130

**i** **22**  
Meer informatie

Petrol Diesel

OIL

- voor de montage en demontage van moeilijk te openen CLIC-leidingkoppelingen met veervergrendeling van brandstof-, airco-, lucht- en hydrauliekleidingen
- geen beschadiging aan steekkoppelingen, brandstofleidingen en brandstofslangen
- snel en eenvoudig scheiden van brandstofleidingen
- voor vrijwel alle leidingkoppelingen van Europese, Aziatische en Amerikaanse voertuigen

**115.1260 Leiding-verbinding ontgrendelset**

**49,90**

5/16" 1/4" 5/16" 3/8" 3/8" 1/2" 5/8" 7/8"

3/8" 1/2" 5/8" 3/4" 5/16"

3/8" 1/2" 5/8"

3/4" 7/8" 5/16" x 3/8"

5/16"



Meer informatie

# MET 3.873 SLAGEN PER MINUUT TREKT HIJ ALLES ERUIT!

- Inclusief 7 adapters voor vrijwel alle injectoren
- Enorm hoog slageffect (3365 (6,3 bar) / 3873 (8 bar) slagen per minuut)
- voor het uitbouwen van vastgebrande verstuivers in de cilinderkop
- Met de betreffende adapter wordt de trekker op de vastzittende verstuiver vastgeschroefd
- neemt weinig ruimte in door compacte uitvoering

## NIEUW

223 L/min	3/4"-19 mm	108,4 dbA
6,3 bar (92 psi)	71,9 m/s²	6 mm
12 bar	119,4 dbA	M18 x 1,5

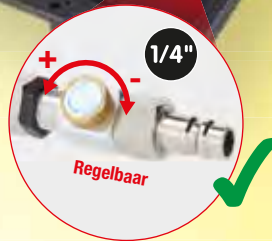

<b>A</b>	M25 x 1,0	Siemens
<b>B</b>	M20 x 1,0	Denso
<b>C</b>	M27 x 1,0	Siemens
<b>D</b>	M27/M17/10 mm	Bosch/Fiat/BMW/PSA/ Mercedes/Renault
<b>E</b>	M18 x 1,5	Adapter
<b>F</b>	M17 x 1,0	Bosch/Mercedes
<b>G</b>	M16 x 1,0	Toyota
<b>H</b>	M14 x 1,5	Bosch/Delphi/BMW



**BOSCH** ✓  
**DENSO** ✓  
**DELPHI** ✓  
**SIEMENS** ✓  
 ... ✓

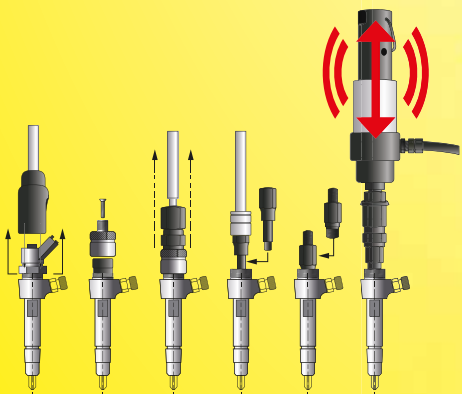

# 269,90

152.1130 Perslucht-verstuivertrekker

**i** **6**  
Meer informatie

285 - 875 mm

**TELESCOPISCH**

150 - 675 mm

500g

200g

1000g

2000g

3000g

Ø 4 mm

Ø 13 mm

Ø 16 mm

Ø 19 mm

400 mm

510 mm

**NIEUW**

**26,90**

**550.1090 Flexibele en telescopische magneethouder- en inspectiespiegelset**

**i** **1**  
Meer informatie

125 mm

6 - 24 V

**4,90**

**550.1504 Proeflampje 6 - 24 V**

**i** **1**  
Meer informatie

11,90

3 - 48 V

**550.1503 Polariteits- en spanningstester 3 - 48 V**

**i** **2**  
Meer informatie

**129,90**

25 m

6 - 24 V

**Spanningstester**

**150.1655**

**i** **2**  
Meer informatie

**1** Ontvanger

**2** Zender met krokodillenklampen

**59,90**

**150.3075 Kortsluitdetector**







Meer informatie





# 369,<sup>90</sup>

 **Accu laden**  
 **Onderhoudsladen**  
 **Reparatie van de accu**  
 **Gelijkstroomvoeding**  

12V  
24V

**geschikt voor 12 en 24 Volt**



Temperatuursensor



**Technische gegevens:**

Accucapaciteit:	12V: 75-500Ah - 24V: 45-250Ah
Spanningsbereik:	220-240V AC, 50/60HZ
Laadspanning:	14,4V - 25A (12V), 28,8V - 12,5A (24V)
Frequentiebereik:	50 Hz
Kabel:	H05RN-F 2x1,0 mm <sup>2</sup>

550.1745 **12V + 24V SMARTcharger tweevoudige hoogfrequente acculader, 25A/12,5A**







Meer informatie





# 367,<sup>90</sup>

 **Accu laden**  
 **Onderhoudsladen**  
 **Reparatie van de accu**  
 **Gelijkstroomvoeding**  

12V  
24V

**geschikt voor 12 en 24 Volt**



12V / 24V digitale accu- en laadcircuittester met geïntegreerde printer



Voor vrijwel alle batterijen

Met printer en 3 rollen papier

**Technische gegevens:**

Scherm:	digitaal
Werkbereik CA / MCA:	40-2.000 CCA
Werkbereik CCA:	40-2.000 CCA
Werkbereik DIN:	40-2.000 CCA
Werkgebied EN:	40-2.000 CCA
Werkgebied IEC:	40-2.000 CCA
Werkbereik JIS#:	40-2.000 CCA
Werkbereik SAE:	40-2.000 CCA
Werktemperatuur:	+0°C tot +55°C
Frequentiebereik:	100 Hz
Meetbereik:	9-36 V
Meetnauwkeurigheid:	+/- 0,5 Megaohm
Spanningsbereik:	9-36 V

550.1649







Meer informatie





# 599,<sup>90</sup>

 **Accu laden**  
 **Onderhoudsladen**  
 **Reparatie van de accu**  
 **Gelijkstroomvoeding**  

12V  
24V

**geschikt voor 12 en 24 Volt**



12V + 24V Startbooster 1400 A



**SAFETY Xtreme**



**Intelligent veiligheidsconcept vermijdt bedieningsfouten:**

De veiligheidsschakeling levert pas stroom op de klemmen als:

- Correct is aangesloten (polen correct)
- De verbinding kortsluitveilig is
- De correcte spanning aanwezig is
- De voertuigaccu in orde is

550.1720

## 1.400 A

**i** **26**  
Meer informatie



3/8"

**329,90**

Gereedschapset met geïsoleerde gereedschappen voor hybride- en elektrische voertuigen

117.1895

2 x		4 mm - 5,5 mm
2 x		PH1 - PH2
6 x		6 - 8 - 10 - 12 - 13 - 17 mm
1 x		185 mm
1 x		165 mm
1 x		3/8"
1 x		3/8": 200 mm
1 x		3/8": 125 mm
10 x		3/8": 8 - 10 - 11 - 12 - 13 - 14 - 16 - 17 - 19 - 22 mm
1 x		200 mm

**i** **43**  
Meer informatie



3/8"

**564,90**

Gereedschapset met geïsoleerde gereedschappen voor hybride- en elektrische voertuigen

117.1890

4 x		2,5 - 3 - 3,5 - 4 mm
3 x		PH1 - PH2 - PH3
3 x		T20 - T25 - T30
1 x		210 mm
1 x		185 mm
1 x		165 mm
1 x		215 mm
1 x		165 mm
1 x		240 mm
2 x		10 - 25 mm
1 x		180 mm
1 x		3/8"
15 x		3/8": 6 - 7 - 8 - 9 - 10 - 11 - 12 - 13 - 14 - 16 - 17 - 18 - 19 - 20 - 22 mm
2 x		3/8": 150 - 250 mm
3 x		3/8": M8 - M10 - M12
1 x		Ø 200 mm
1 x		200 mm
1 x		500 m

**i** **18**  
Meer informatie

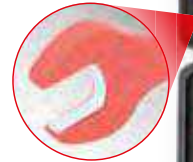

**329,90**

Steeksleutelset met veiligheidsisolatie

118.1500

18 x		7 - 8 - 9 - 10 - 11 - 12 - 13 - 14 - 15 - 16 - 17 - 18 - 19 - 20 - 21 - 22 - 23 - 24 mm
------	--	---

**i** **1**  
Meer informatie

<44.500 V



**179,90**

Geïsoleerde reddingsstang

150.0913



Meer informatie

# DE INSTAPSET VOOR ELEKTROMOBILITEIT

## ecoLine



1



2,5 - 4 - 5,5 mm PH0 - PH1 - PH2



2

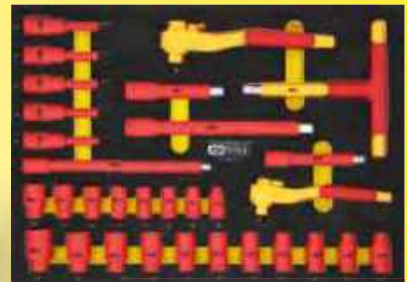

3/8" 8-18 mm 125+250 mm  
1/2" 10-24 mm 125+250 mm  
4-5-6-8-10 mm  
3/8"+1/2"



117.0222

117.0223



Vierkant gatenpatroon voor accessoires



afsluitbaar door ingebouwd cilinderslot



werkblad met 10 mm dikke anti-slipmat



Zelfsluitend en SOFT-CLOSE-functie



2 x rol- en draaiem Ø wielen: 125 mm

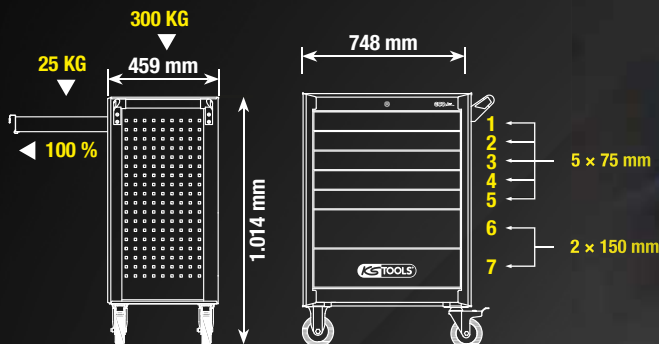

# 1299,00

## INCLUSIEF 42 GEREEDSCHAPPEN

ECOline gereedschapwagen met 42 geïsoleerde gereedschappen voor hybride- en elektrische voertuigen

117.6144

**4299,00**



**+**

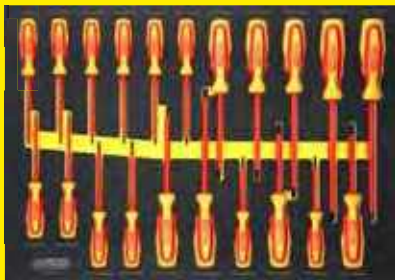
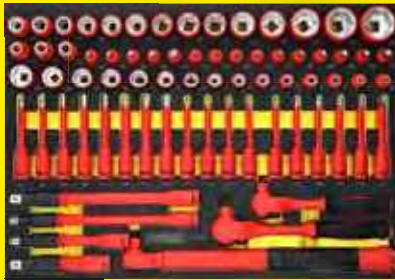

117.6155 PERFORMANCEplus gereedschapwagen €10 met 164 geïsoleerde gereedschappen voor hybride- en elektrische voertuigen

**DE OMVANGRIJKSTE IN Z'N KLASSE**



**9,90**

117.0222

Dakbord met bliksemsymbool en zuignap



De elektromobiliteitscatalogus van 188 pagina's vindt u bij [www.kstools.com](http://www.kstools.com)

**14,90**

117.0226

Bord met bliksemsymbool

**69,90**

117.1550

Afzetpalenset met ketting



**2x**

**139,90**

117.1545

2 x Schaarbarrière van kunststof



**i**  **4**  
Meer informatie

Ø 22,0 - 28,0 mm

Ø 15,0 - 21,0 mm

Ø 17,0 - 25,0 mm

**Koppelingscentreer- gereedschapsset**

**8,90**

150.2180 Ø 15,0 - 28,0 mm



**i**  **11**  
Meer informatie

150 kg

310 mm

450 mm

**394,90**

300 mm

160.0910 Universele versnellingsbakhouderset



**i**  **3**  
Meer informatie

- 1 Vulgereedschap A Monteren en demonteren
- 2 Olie aftappen, gering debiet
- 3 Vulniveau controleren
- 4 Olie aftappen, volledig debiet

**24,90**

**9G-TRONIC**

56 mm

20 mm

74,5 mm

9 mm

28,5 mm

39,5 mm

9 mm

152 mm

48 mm

150.9695



**i**  **24**  
Meer informatie

# DE OMVANGRIJKSTE!

**199,90**

**INCLUSIEF 23-DELIGE ADAPTERSET**

150.9261		1/8-27 NPT Ford
150.9262		BMW, Honda, Nissan etc.
150.9263		VAG
150.9264		VAG, Porsche
150.9265		M10 x 1.0 VAG, Mini Cooper
150.9267		M12 x 1.5 Mercedes
150.9268		M24 x 1.5 VAG DSG
150.9269		M22 x 1.5 VAG CVT
150.9271		M18 x 1.5 Skoda
150.9272		M30 x 1.5 VAG, Skoda
150.9273		Universal Flexible 300 mm, Honda, Hyundai, Kia, etc.
150.9274		5/16-24 (UNF) Volvo
150.9276		M18 x 1,5 Toyota / Lexus
150.9277		M8 x 1,0 Nissan / Infinity
150.9278		ATF-Adapter V.W, Passat
150.9562		Nissan Juke M12 x 1,25
150.9563		Mini Cooper M14 x 1,5
150.9564		Nissan M10 x 1,5
150.9566		GM M12 x 1,75
150.9567		Mercedes 725-9G
150.9102		VAG 7 DSG
150.9103		VAG 7 DSG
150.9104		VAG 7 DSG

**NIEUW!**

150.9105 Universeel vulsysteem voor versnellingsbakolie, incl. 23 delige adapterset



**i**  **4**  
Meer informatie



**111,90**

**Ø 30 mm**

**McPherson veerpotsteun voor versnellingsbakkrick**

160.0195

**i**  **7**  
Meer informatie



6 mm

**99,90**

**Speciale set montagegereedschappen voor schokdempers met een uitslag-begrenzingsveer**

150.9545





**VOOR UW VEILIGHEID**  **GETEST!**

**i**  **6**  
Meer informatie

universeel voor 90% van alle gangbare schroefveren bij personenauto's en bestelwagens



Ø 80 - 160 mm

Ø 140 - 195 mm

**BELASTING max 26000 N**

**451,90**

**Universele set veerspanners**

500.8400

**Technische gegevens:**

Veerdruk max.:	2600 kg
Spanwijdte max.:	355,0
Veercapaciteit:	80,0 - 195,0 mm

- ideaal voor het monteren en demonteren van Mc Pherson veerpoten
- benodigd bij het vervangen van schokdempers of schroefveren
- universeel voor 90% van alle gangbare schroefveren bij personenauto's en bestelwagens
- kostenbesparend en solide alternatief voor gangbare veerspanners
- ook voor conische en kegelveren geschikt
- TÜV-goedgekeurd

**VOOR UW VEILIGHEID**



**GETEST!**

**i** **11**  
Meer informatie

**TUV SUD**

1/2" x 1/2", 100 Nm

Ø 30 mm

**372,90**

Ø 90 - 140 mm

**500.8765** Telescopische centerspannerset Audi en Seat voor binnenliggende veren

**VOOR UITBREIDING**

**i** **2**  
Meer informatie

**VOOR VEERSPANNER**  
**500.8755 + 500.8765**

Ø 95-110 mm

**99,90**

Toepassingsgebieden:  
Mercedes E-klasse (W211 / W212), C-klasse (W204), GLA (X156),  
GLK (X204), Ford Focus II (MK2), BMW 1-serie (E81), Volkswagen Passat (B8 / 3G)

**500.8770** Veerbekken per paar Ø 95-110 mm

**VOOR UITBREIDING**

**i** **9**  
Meer informatie

**TUV SUD**

Ø 30 mm

Ø 90 - 140 mm

Ø 75 - 115 mm

**338,90**

**500.8755** Universele set telescopische centerspanners voor binnenliggende veren

**WARNING - ACHTUNG - ADVARSEL**  
**ADVERTENCIA - AVERTISSEMENT**



# VOOR 95% VAN ALLE VOERTUIGEN



Meer informatie

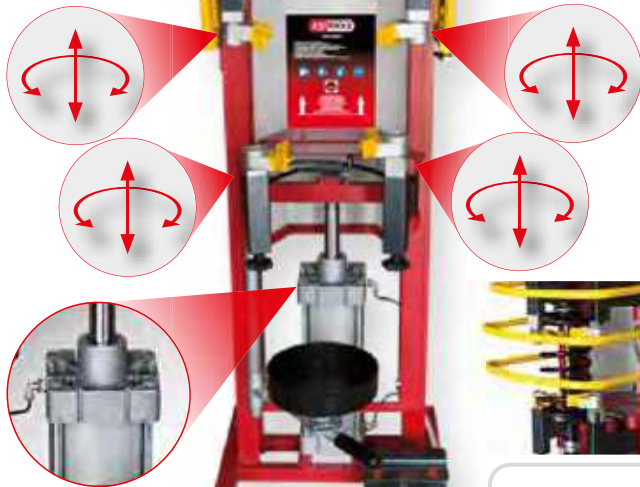

max  
12000  
N

**1149,00**

Pneumatische staande veerspanner,  
max. 10 bar

500.8800



Meer informatie



max  
24000  
N

**1599,00**

Perslucht-stand-veerspanner  
met dubbele cilinder

500.8810

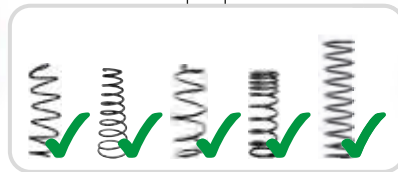

met dubbele cilinder



Meer informatie



- gemakkelijk in het gebruik
- speciaal-gereedschapsstaal
- ideaal voor veerpoten
- optimaal voor een veilige staande positie bij het monteren en demonteren
- met 4 bevestigingspennen en 4 tapeinden
- levering vindt plaats met 2 borgveren voor de montage

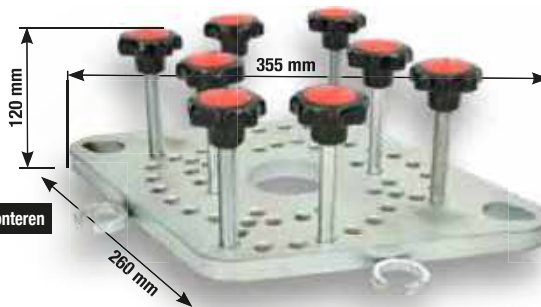

**281,90**



500.8801 Adapterplaat voor pneumatische aangedreven staande veerspanner

## VEERSPANNERSET, INCLUSIEF ADAPTERPLAAT



Meer informatie



Pneumatische  
veerspanner incl.  
Adapterplaat

**1349,00**

500.8805



Meer informatie



Pneumatische  
staande veerspanner  
met dubbele cilinder,  
incl. adapterplaat

**1799,00**

500.8815

## CONFIGUREREN ZOALS U DAT WENST



440.9051



1199,90



GROTER DAN U DENKT

REM



440.9087



2499,90

SILENT-LAGERS



440.9025

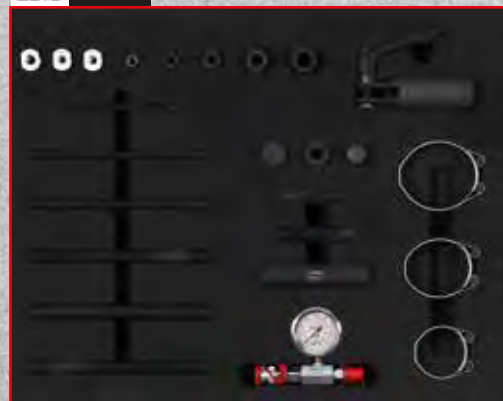

HYDRAULISCHE CILINDER ZONDER BEDIENINGSGEREEDSCHAPPEN



440.9161



3399,90

COMPACTE WIELLAGERS



440.9026

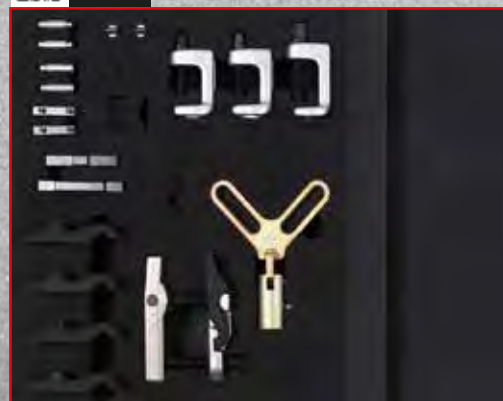

AS



# HALVE LEVEN

# MODULO 2



Ø 155 mm

1.701 mm

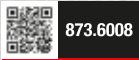

873.6008

**PERFORMANCEplus P40 ZWART/ROOD gereedschapswagen met 4 schuifladen**

**ZONDER GEREEDSCHAP**

**2760,50**

Meer informatie

2200 mm

**899,90**

Hydrauliekpompset met vak voor P40

440.9004

**999,90**



440.9076



25

**WIELLAGERS**



76



**1999,90**

**799,90**



440.9061



26

**SCHOKDEMPERS**



61



**1899,90**

**i** 1  
Meer informatie

**99,90**

max. 8 bar

450 mm

1/4" PT

Voor universele-aandrijfshoezen

515.3100 **Pneumatische-asmanchettenspreider**

**i** 1  
Meer informatie

100 mm

Ø 30 mm

255 mm

**49,90**

150.1850 **Universele trekker voor cardanassen**

**i** 1  
Meer informatie

VA FE

0 - 45 mm

270 mm

**39,90**

115.1056 **Slangklemtang voor moment aanhalen**

**i** 1  
Meer informatie

max. 12 mm

**49,90**

115.1590 **Spantang voor RVS-kabelbinders met kogelsluiting**

**vanaf 25,90**

RVS kabelbinders met kogelsluiting

200 - 350 mm

115.1591		100	4,6 x 200 mm	25,90 €
115.1592		100	4,6 x 250 mm	25,90 €
115.1593		100	4,6 x 350 mm	28,90 €
115.1594		100	4,6 x 500 mm	37,90 €

**i** 1  
Meer informatie

10 mm

**UNIVERSAL**

**39,90**

700.5662 **Spreadgereedschap voor klemboringen**

**i**  **1**  
Meer informatie

**24,90**



1/2"  
30 mm

**Speciale fuseekogeldop voor Mercedes**

150.1721  Mercedes W167, W205, W213, W238, W253, W25



**i**  **6**  
Meer informatie

**369,90**



**KSTOOLS VIBRO-POWER 515.3881**

10 mm  
110 mm  
10 mm  
110 mm  
10 mm  
130 mm  
10 mm  
100 x 25 x 12 mm

31 x 1 sec.

**VIPRO**

**515.3880 Vibro-impact pneumatische beitelhamerset**









**i**  **3**  
Meer informatie

**31,90**

**10 mm**

**Klemschroef-uitdrukset**

700.5635



**i**  **1**  
Meer informatie

**159,90**

- trillingsondersteund demonteren van spoorstangen, contraschroefbevestigingen of schroefbevestigingen in de wielophanging enz.
- De speciale trildoorn geeft een impactimpuls aan de los te maken schroefverbinding, waardoor roestvorming vrijkomt en het losmakende proces wordt ondersteund
- Pneumatische beiteladapter (10 mm) voor gebruik met gangbare pneumatische beitelslaghamers

27 mm

290 mm

10 mm

65 mm

**150.1608 Vibro-Impact demontagegereedschap voor spoorstangen**







Meer informatie



168,90

700.1495 Universele ashefboom met ketting



- door de flexibele ketting kunnen wieldraagarmen van verschillende constructies zonder grote krachtsinspanning veilig naar beneden worden gedrukt



Meer informatie

121,90

- stabiele trapezium schroefdraadspindel
- voetpedaal voor fijninstelling (20 mm)
- de ideale werkplaatskrik in veel situaties



160.0342 Telescopische steun



Meer informatie



89,90

911.6187 Telescoombreekijzer met zwenkop



Meer informatie

99,90



700.1465 Spelingstester



**i** **22**  
Meer informatie

42 40 38 36 34  
32 30 28 26 24  
#1  
#2  
#3  
#4  
M12  
M10  
M12 M10  
TR20

**700.2355** **Getrapte-drukbusset** **499,90**



**i** **4**  
Meer informatie

**79,90**

30-35 mm 35-40 mm 40-45 mm  
360 mm  
1/2" / 32 mm

**150.1125** **Speciale sleutelset voor axiaalgewrichten**



**i** **2**  
Meer informatie

**M12**

**NIEUW**

115 mm 72 mm

**19,90**

**Bit-dopsleutelset voor veelrand (XZN®)-schroeven, kracht**

**515.0595** 1/2"

**i** **30**  
Meer informatie

1 x  $\emptyset$  90 - 130 mm  
1 x  
4 x M 14  
4 x M12 x 1,25  
M12 x 1,5  
M12 x 1,25  
M12 x 1,5  
M14 x 1,5  
1 x M18 x 2,5 x 230 mm  
M57 x 2

**4,3 Kg**

**224,90**

**700.1530** **Universele wielnaaf- en cardanastrekker**



# MINDER PERSONEEL NODIG, MEER WINST.

## RUIT LOSMAKEN ZONDER EXTRA HULP!

140.2630

### Universeel eenmans uitbouwgereedschap voor ruiten

- ideaal voor het vakkundig en voorzichtig uitbouwen van gelijmde voorruitenevens de meeste achter- en zijruitene
- met grote katrol, waardoor er minder krachtinspanning en minder gevaar op breken van de draad is
- draaddoorvoer direct bij de ruit, daardoor is het in de meeste gevallen niet nodig bekledingsdelen te demonteren
- eenvoudige bediening door een persoon
- bijzonder hoogwaardige zuigpomp voor het betrouwbaar vastzuigen van de ruit



# ONE MAN CUT

**NIEUW**

Professionele beschermplaatset, 4-dlg  
2x 270x200 mm + 2x 450x300 mm

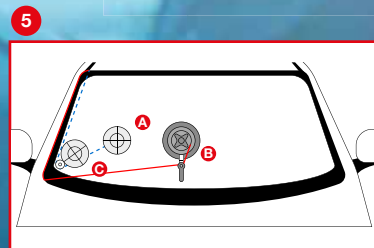
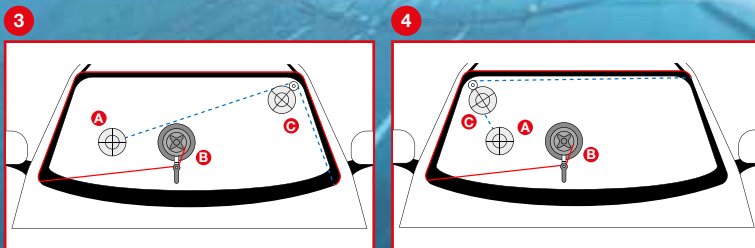
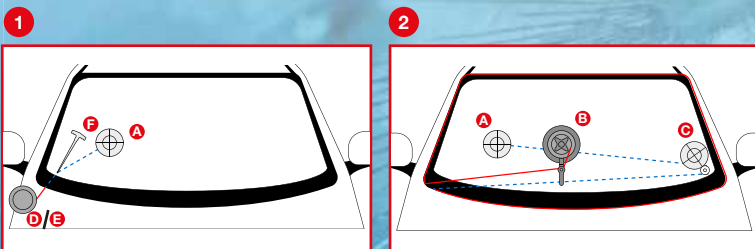

# 599,90

Inclusief



**NIEUW**

**0**  
20 mm

**155 mm**

**14,90**

**OOK VOOR DOT5.1, ENV4 EN ENV6**

- Dot3 ✓
- Dot4 ✓

150.1969 Remvloeistoftester voor DOT en ENV

**1**

**27,90**

150.8258 Pompspuitfles voor remmenreiniger

**Speciaal voor remmenreiniger**

**2**

**10,90**

150.1935 universele haakset, vervormbaar

**2**

**14,90**

150.2235 Universele haakset, star

**12**

**49,90**

150.2400

Speciale dopsleutelset voor remklauwbouten

- 1/2" 11,5 mm 14 mm 15 mm 20 mm AS 22 mm
- 1/4" 9 x 20 mm
- 3/8" 7 x 72 mm 7 x 92 mm 9 x 50 mm 11 x 100 mm
- 3/8" 7 x 25 - 8 x 25 mm

**41**

**99,90**

150.1970 Gereedschapsset voor het terugstellen van remzuigers



Meer informatie

# DE UNIVERSELE GENIE



**UNIVERSAL**  
Voor 95% van alle voertuigen



150.2440 Universele gereedschapset voor terugstellen van remzuigers

**129,90**



Meer informatie

**699,90**



5L



Meer informatie

**49,90**



min. 18 mm

universeel verstelbaar



Max. 70 mm

Min. 28 mm

160.0718 Universele adapter voor ontluichtingsaansluiting, verstelbaar



Meer informatie

**TOYOTA & LEXUS**

**NIEUW**

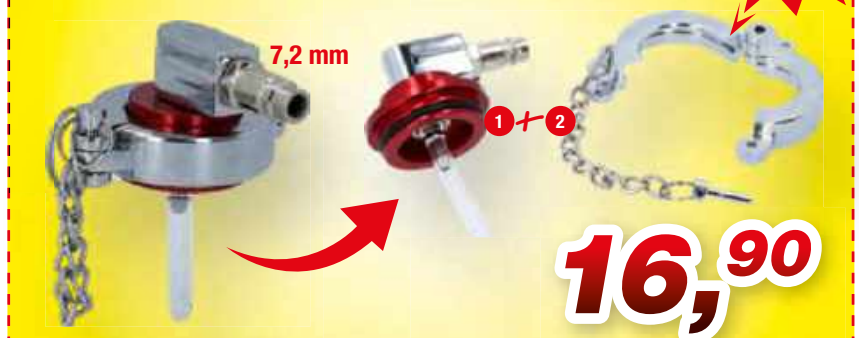

7,2 mm

1 + 2

**16,90**

160.0719 Universele ontluichtingsnippel voor Toyota en Lexus

160.0700 Remontluchtapparaat KS5



**i**  **6**  
Meer informatie



1,200 mm

11 mm  
10 mm  
9 mm  
8 mm  
7 mm

**69,90**

160.0725 Remontluchtsleutelset



**i**  **11**  
Meer informatie

**DE COMPLETE**



1,200 mm

180 mm

9x12 mm

11 mm  
10 mm  
7 mm  
11 mm  
11 mm  
10 mm  
11 mm

12 mm  
29 mm  
39 mm  
45 mm  
60 mm  
70 mm  
75 mm  
85 mm

**74,90**

518.0320 Remontluchtgereedschapset voor VAG



**i**  **1**  
Meer informatie



4,75 mm (3/16")

21 mm  
31 mm  
41 mm  
61 mm  
76 mm

**39,90**

120.1006 Remleidingbuig-gereedschap



**i**  **1**  
Meer informatie



4,75 mm (3/16")  
6,35 mm (1/4")

**29,90**

120.1004 Remleidingrichtgereedschap / -buiggereedschap

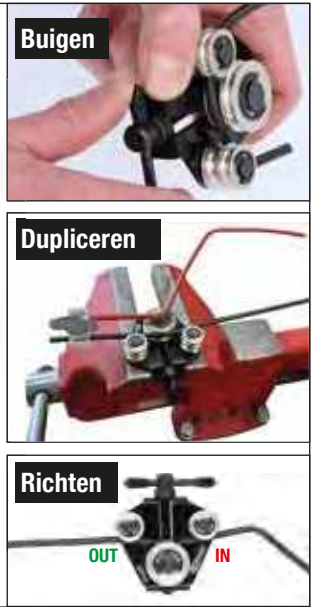



		DIN	SAE	4,75 mm	5,0 mm	6,0 mm	Met pijpbuiger	Met pijpsnijder	Met pijponbramer	mechanisch	Met hydraulische spindel	Handpomp	In de koffer
1	122.1215	✓	✗	✓	✗	✗	✗	✗	✗	✓	✗	✗	✗
2	122.1290	✓	✓	✓	✓	✓	✓	✓	✓	✗	✓	✗	✓
3	122.1260	✓	✓	✓	✓	✓	✗	✗	✗	✗	✗	✓	✓

Meer informatie

4

49,<sup>90</sup>

1 **FLAREFIXeco 4,75 mm universeel remleiding-felsapparaatset**

122.1215

Meer informatie

16

## FLAREFIX

169,<sup>90</sup>

2 **FLAREFIX 1 universele felsset voor remleidingen met hydraulische spindel**

122.1290

**DIN**

**SAE**

3,0-12,0 mm

3,0-6,0 mm

3,0-16,0 mm

4,75-5,0 mm, SAE

6,0 mm, SAE

4,75-5,0-6,0 mm, SAE-90°

4,75-5,0 mm, DIN

6,0 mm, DIN

M12x1,25

4,75 mm, 3/16"

5,0 mm

6,0 mm

HYDRAULISCH, PRAKTISCH, GOED!

Meer informatie

11

## FLAREFIX II

### Hydraulic

299,<sup>90</sup>

3 **FLAREFIX 2 universele felsset voor remleidingen met hydraulische cilinder**

122.1260

**DIN**

**SAE**

max. 2,5t

4,75(3/16") 5/8mm

M12 x 1,25 mm

4,75-5,0 mm, SAE

6,0 mm, SAE

4,75-5,0-6,0 mm, SAE-90°

4,75-5,0 mm, DIN

6,0 mm, DIN

M12x1,25

4,75 mm, 3/16"

5,0 mm

6,0 mm

**i**  **9**  
Meer informatie



<b>1</b> Ford/PSA	<b>2</b> BMW	<b>3</b> VAG	<b>4</b> Mercedes	<b>5</b> DAF/MAN
<b>6</b> GM	<b>7</b> Ford	<b>8</b> Ford	<b>9</b> Ford	

**24,90**

150.1040

Speciale 3/8" olieversproefselset voor kunststof olieaftappluggen, 9-dlg

**i**  **6**  
Meer informatie



**69,90**

- Gereedschap voor het vlakken van het contactvlak van carterpanstoppen
- Het vlakken van de zitting waarborgt een goede afdichting van de carterpanstop
- exacte centrering t.o.v. het contactvlak
- Set is inclusief adapter voor originele olie-aftapplug en overmaat schroefdraad-reparatieset
- in stevige kunststof koffer

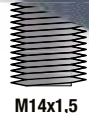
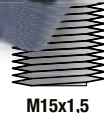
		
0° / Ø 22	M14x1,5	M15x1,5



150.1485

Zittingfreeset voor olie-aftappluggen

**i**  **1**  
Meer informatie



**7,5 liter**

Ø 385 mm

**12,90**

150.9359

Opvangbak 7,5 liter



**i**  **30**  
Meer informatie

1/2" 21 mm  
Ø 63 - 102 mm

**99,<sup>90</sup>**

**3/8"**

65-14, 65/67-14, 66-6, 68-14, 73-14, 74-15, 74/76-15, 75/77-15, 76-8, 76-12, 76-14, 76-30, 78-15, 80-15, 80/82-15, 86-18, 86-16, 90-15, 92-10, 93-15, 93-36, 93-45, 95-15, 96-18, 100-15, 106-15, 108-15, 108-18

150.9350 **3/8" Oliefiltersleutelset**



**i**  **24**  
Meer informatie

2,0 L

**99,<sup>90</sup>**

VW Lexus Lotus Ford Nissan  
Subaru Mitsubishi Land Rover Hyundai Audi  
Chrysler Toyota Citroën Volvo Cadillac  
Citroën Buick Volvo Buick universeel

150.9130 **MASTER Olievultrechterset met draibare gebogen arm**



**i**  **4**  
Meer informatie

**VOOR VAG**

met draibare gebogen arm voor moeilijk toegankelijke plekken

**14,<sup>90</sup>**

2,0 L

150.9155 **Olievultrechter met draibare arm onder een hoek voor VAG**



# OP DE BRUG - KLAAR - AAN HET WERK!

van massief rubber

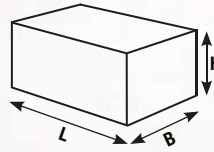

Onderdelen	L mm	B mm	H mm		
160.0476	1	160	120	20	4, <sup>90</sup> €
160.0477	1	160	120	30	6, <sup>90</sup> €
160.0478	1	160	120	40	8, <sup>90</sup> €
160.0479	1	160	120	60	12, <sup>90</sup> €
160.0480	1	160	120	80	16, <sup>90</sup> €
160.0481	1	160	120	100	20, <sup>90</sup> €
160.0482	1	160	120	115	23, <sup>90</sup> €
160.0483	1	116,5	116,5	36,5	5, <sup>90</sup> €
160.0499	1	160	120	85	17, <sup>90</sup> €

**NIEUW**



PE (polyethyleen)

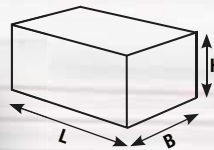

Onderdelen	L mm	B mm	H mm		
160.0437	1	250	150	55	14, <sup>90</sup> €
160.0438	1	250	150	100	26, <sup>90</sup> €
160.0486	1	340	150	55	19, <sup>90</sup> €
160.0489	1	340	130	100	31, <sup>90</sup> €

**NIEUW**



van massief rubber met een versterkte kern



**NIEUW**

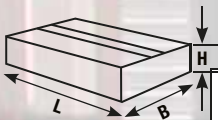

Onderdelen	L mm	B mm	H mm		
160.0484	1	373	100	35	39, <sup>90</sup> €



van slagbestendig kunststof



**NIEUW**



- Model 3 ✓
- Model S ✓
- Model X ✓
- Model Y ✓



van massief rubber

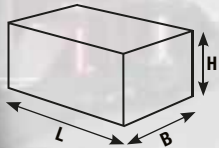

Onderdelen	L mm	B mm	H mm		
160.0391-TD	4	155	125	35	34, <sup>90</sup> €



van massief rubber



**NIEUW**

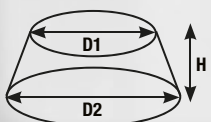

Onderdelen	D1 mm	D2 mm	H mm		
160.0485	1	78	105	60	9, <sup>90</sup> €

160.0460 Tesla Model 3, S, X, Y

**23,<sup>90</sup>**





### van rubber en staalplaat

Meer informatie

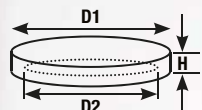

	D1 mm	D2 mm	H mm	Ravaglioli	Grazia	OMCN	Intertech	MAHA	Werther	Nussbaum	AMI	Twin Busch	Sirio	Space	Launch	RP Tools	J.A. Becker	ATH	HOFMANN	Hermann		
A	160.0463	120	113	22				✓														8,90 €
B	160.0465	123	108	25	✓				✓													8,90 €
C	160.0475	120	110	19													✓	✓	✓	✓		8,90 €



### van rubber

Meer informatie

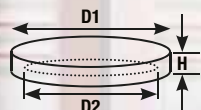

	D1 mm	D2 mm	H mm	Ravaglioli	Grazia	OMCN	Intertech	MAHA	Werther	Nussbaum	AMI	Twin Busch	Sirio	Space	Launch	RP Tools	J.A. Becker	ATH	HOFMANN	Hermann		
A	160.0466	125	120	24						✓	✓											11,90 €
B	160.0467	140	130	25								✓										5,90 €
C	160.0468	100	85	14	✓								✓	✓								4,90 €
D	160.0464	120	113	23				✓														4,90 €
E	160.0469	120	108	32								✓			✓	✓						7,90 €
F	160.0470	130	125	14	✓								✓	✓		✓						4,90 €
G	160.0471	140	125	30								✓										7,90 €
H	160.0472	150	130	23	✓																	6,90 €
I	160.0473	120	105	30								✓										6,90 €
J	160.0474	120	110	19													✓	✓	✓	✓		4,90 €
K	160.0490	100	80	21	✓													✓	✓	✓	✓	3,90 €
L	160.0491	120	108	26	✓	✓																4,90 €
M	160.0492	120	110	26	✓	✓																4,90 €
N	160.0493	145	108	24	✓		✓															7,90 €
O	160.0494	145	135	26	✓																	6,90 €
P	160.0495	160	135	28			✓															6,90 €
Q	160.0496	140	103	25						✓												7,90 €
R	160.0497	150	127	25	✓																	5,90 €
S	160.0498	140	132	28																		8,90 €

**i** **1**  
Meer informatie



**7,90**

**800.0156** Magnetschaal, kunststof, Ø 150 mm



**i** **1**  
Meer informatie



330 mm

**150.2032** Metalen-ventieltrekker, 330 mm



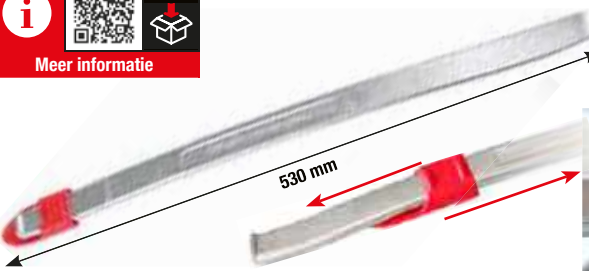

**9,90**

**i** **1**  
Meer informatie



530 mm

**911.8135** Runflat bandenlichter en montagehefboom



**27,90**

**i** **1**  
Meer informatie



**49,90**

**800.0190** Magneethouder, metaal, 390 mm



**i** **1**  
Meer informatie



600 mm

0 - 12 bar

1/4" PT

**19,90**

**515.1950** Bandenspanningsmeter

**i** **1**  
Meer informatie



400 mm

0 - 10 bar

1/4" PT

**61,90**

**515.1960** Geijkte bandenspanningsmeter

**GEIJKT**

**i** **5**  
Meer informatie



60 x 100 mm

70 g

9 mm

**56,90**

**150.1070** Bandvulkaniseerset voor motorvoertuigen, inclusief 100 mm draad



**OPTIONEEL BIJ TE KOPEN**

60 stuks

**17,90**

**150.1072**



**i**  **1**  
Meer informatie

**89,90**

Slijpset voor aluminium wielnaven  
Ø 150 mm, binnen-Ø 90 mm

100.5080

**OPTIONEEL BIJ TE KOPEN**  
**34,90**  
100.5077

**VOOR:**   **NA:** 

**i**  **4**  
Meer informatie

**NIUW**

8 mm 10 mm 8 mm 8 mm

Doppenset voor speciale aluminium meerdelige OZ-velgen

**14,90**

515.0795  

**i**  **3**  
Meer informatie

**39,90**

1/2" Dopsleutelset, spiraal-profiel kracht, 3-dlg, 17-21 mm

913.1270   17 - 19 - 21 mm

**i**  **2**  
Meer informatie

19,5 mm 21,5 mm 18,5 mm 20,5 mm

Speciale krachtdoppenset voor aluminium-velgen voor Ford, 18,5 / 19,5 / 20,5 / 21,5 mm

**27,90**

515.0895   18,5 - 19,5 - 20,5 - 21,5 mm

**i**  **1**  
Meer informatie

**VOOR MERCEDES**

max. 75 Nm

**17,90**

1/2" Kracht-torsieverlengstuk, 75 Nm

515.1491 

**i**  **10**  
Meer informatie



**Slotbout-demontageset**

913.1480  18 - 19 - 20 - 21 - 22 - 23 - 24 - 25 mm

**59,90**



**i**  **15**  
Meer informatie

**Velgslotdemontageset**



**139,90**



913.1430

**UNIVERSEEL GENIAAL - ZE PASSEN ZICH AAN ELK PROFIEL AAN!**

# ROBUUSTE 1/2" KRACHTDOPPENSET VOOR ALUMINIUM VELGEN

**1**

Meer informatie

21 mm 19 mm 17 mm

**17,90**

515.1070 1/2" 17 - 19 - 21 mm

**2**

Meer informatie

15 mm 17 mm 19 mm 21 mm 22 mm

**24,90**

515.0870 1/2" 15 - 17 - 19 - 21 - 22 mm

**3**

Meer informatie

**69,90**

17 mm 15 mm 19 mm 22 mm 23 mm

21 mm 17 mm 21 mm 24 mm

1/2" 15 - 17 - 19 - 21 - 22 - 23 - 24 mm

7/8" 17 mm MS21

515.0890

**4**

Meer informatie

15 mm 17 mm 19 mm 21 mm 22 mm 23 mm 24 mm

18,5 mm 19,5 mm 20,5 mm 21,5 mm 17,5 mm 22,5 mm

**139,90**

**DE COMPLETE ALLESKUNNER**

515.0885 1/2" 15 - 17 - 19 - 21 - 22 - 23 - 24 mm 7/8" 17 mm MS21 17 - 19 - 21 mm 18,5 / 19,5 - 20,5 / 21,5 - 17,5 / 22,5 mm

	515.1072 15 mm	515.1073 17 mm	515.1075 19 mm	515.1076 21 mm	515.1077 22 mm	515.1078 23 mm	515.1079 24 mm	515.1089 Tesla 7/8"	515.2055 Mercedes 17 mm	515.2060 Hyundai KIA MS21	913.1271 Spiraal-uitdraaidop 17 mm	913.1272 Spiraal-uitdraaidop 19 mm	913.1273 Spiraal-uitdraaidop 21 mm	515.0896 Ford 18,5 / 19,5 mm	515.0897 Ford 20,5 / 21,5 mm	515.0899 Ford 17,5 / 22,5 mm	515.1134 Verlengstuk, kracht, 75mm
<b>1</b>	X	✓	✓	✓	X	X	X	X	X	X	X	X	X	X	X	X	X
<b>2</b>	✓	✓	✓	✓	✓	X	X	X	X	X	X	X	X	X	X	X	X
<b>3</b>	✓	✓	✓	✓	✓	✓	✓	✓	✓	✓	X	X	X	X	X	X	X
<b>4</b>	✓	✓	✓	✓	✓	✓	✓	✓	✓	✓	✓	✓	✓	✓	✓	✓	✓

**i** **1**  
Meer informatie

Opladbaar met USB-C-kabel (inclusief)

**16,90**

**350 Lumen**

**UV LED**

**POWER-AAA Li-Ion 800mAh**

Met laserpointer

**COB-LED-inspectielamp  
350 lumen met UV-spot-LED  
en laserpointer**

150.4400

**i** **1**  
Meer informatie

**14,90**

**85 Lumen**

**2 x AA**

**perfectLight zaklamp  
85 lumen**

150.4370

**i** **1**  
Meer informatie

**MAX. 350 Lumen**

**MAX. 100 Lumen**

**270°**

**DE 'MUST HAVE'!  
VOOR WERKPLAATS OF OUTDOOR**

**14,90**

**Li-Ion 3,7 V 1200 mAh**

**Sensorschakelaar**

**On/Off**

**Power Display**

**Bewegingssensor**

**XPE LED 2 lichtniveaus**

**COB LED 3 lichtniveaus**

**Grootte instelbaar**

**95 g**

**max 8 h** **4,5 h** **+**

Modi	COB 100%	COB 40%	COB rot	XPE 100%	XPE 40%
LED	270° 3 Watt COB LED			1 Watt High Power XPE LED	
40%	350 LM	150 LM	-	100 LM	40 LM
	3 h	6 h	8 h	4 h	8 h

**17,90**

**500 Lumen**

**250 Lumen**

360°

180°

ON OFF

USB

1200 mAh lithium-ion-accu (inclusief)

of

3 x AAA batterij (wordt niet meegeleverd)

Inclusief USB-powerbank-functie

20 %	●
40 %	●●
60 %	●●●
80 %	●●●●
100 %	●●●●●

150.4510

max. 3 h

3 h

+

IP65

**19,90**

**300 Lumen**

**130 Lumen**

ON OFF

USB-A OUT

USB-C IN

Geïntegreerde lithium-ion-accu 1.200 mAh

20 %	●
40 %	●●
60 %	●●●
80 %	●●●●
100 %	●●●●●

150.4505

max. 3 h

3 h

+

IP65

**16,50**

**150 Lumen**

**60 Lumen**

360°

180°

ON OFF

Micro USB

20 %	●
40 %	●●
60 %	●●●
80 %	●●●●
100 %	●●●●●

150.4495

max. 3,5 h

2,5 h

IP20

**37,50**

**550 Lumen**

**250 Lumen**

ON OFF

USB-A OUT

USB-C IN

Geïntegreerde lithium-ion-accu 1.200 mAh

20 %	●
40 %	●●
60 %	●●●
80 %	●●●●
100 %	●●●●●

150.4490

max. 3,5 h

3 h

+

IP65

**i**  **11**  
Meer informatie



**20-200 Nm**

met Keurmerk  
**DIN EN ISO 6789**  
**Certificaat**  
Nauwkeurigheid

**119,90**

516.2400 1/2" 10 - 13 - 17 - 19 - 21 - 24 mm

125 mm

10 mm 13 mm 17 mm 19 mm 21 mm 24 mm

17 mm 19 mm 21 mm

500 mm

1/2"

**i**  **8**  
Meer informatie

**VOOR BANDENWISSEL IN RECORDTEMPO**

**THE DEVIL**

**1600 Nm**

2 x Ø 150 mm

10 m

0 - 12 bar

1/2"

21 mm 19 mm 17 mm

**NIEUW**

**119,90**

515.2100

Uw dealer

 LL23-06NL\_EUR

KS Tools Werkzeuge - Maschinen GmbH  
Seligenstädter Grund 10 - 12  
D-63150 Heusenstamm  
Mail: [aftersales@kstools.com](mailto:aftersales@kstools.com)  
Web: [www.kstools.com](http://www.kstools.com)  
 **DUITSLAND**

Met het verschijnen van deze folder komen alle voorgaande actiepijzen te vervallen. Verkoop alleen via de vakhandel. Druk- en zetfouten, technische veranderingen en fouten voorbehouden. Alle prijzen in EUR excl. BTW, geldig tot 30-09-2024.